



Jan Václav Mrkvička, *Préparation de conserve pour l'hiver*, fin XIX<sup>e</sup> s.

- Daily life in Sofia  
from 16<sup>th</sup> to 19<sup>th</sup> century  
through the ceramics

## ● Archaeological excavations, Sofia



- Site of the Serdica Amphitheatre,  
Regional History Museum, Sofia  
Director of excavations : **Jharin Velichkov**,  
Assistant directors : **Katia Trendafilova**, **Unian Meshekov**  
(НИИКН, National Institute of Immovable Cultural Heritage)

Plan de la ville de Sofia / Map of the city of Sofia, 1887



## ● Food preparation

### ● The Bread: from 16th to 20th century

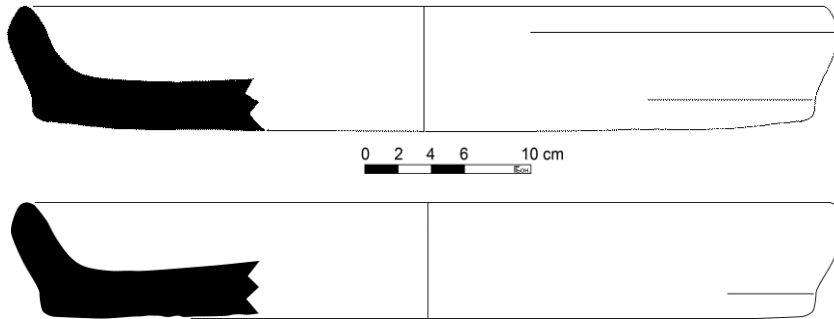

D = 30/40cm to 1m



### Notary inventories 18th-1st ½ 19th century

- 13 of 104 inventories, mention « **iron andirons** »
- 0 of 104 inventories, mention 'plates for bread'



Joseph Oberbauer, The old bakery, 1892



J. V. Mrkvička, Baker, 1887



J. V. Mrkvička, Bread seller, 1888

# ● Food preparation

## ● Cooking pottery: pots

16th century

late 16th century

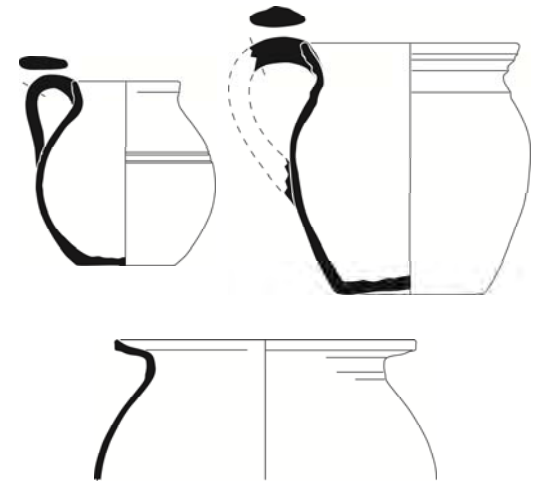

V max 2l



● Food preparation

● Cooking pottery: pots

late 16th-17th century

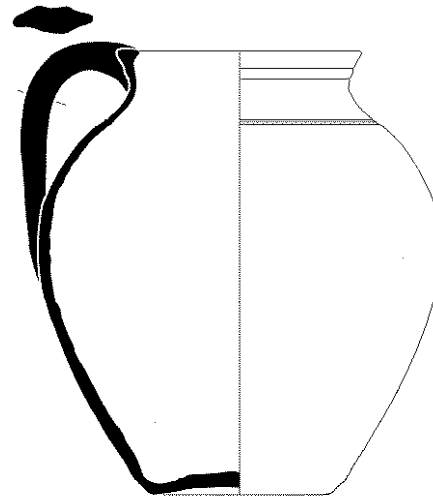

17th century

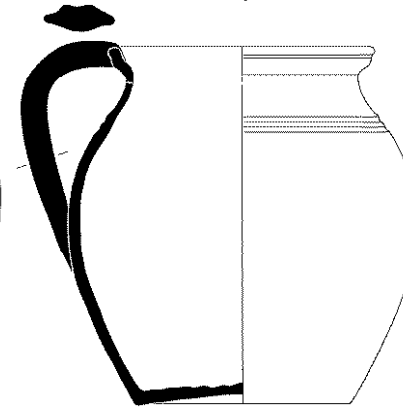

unglazed

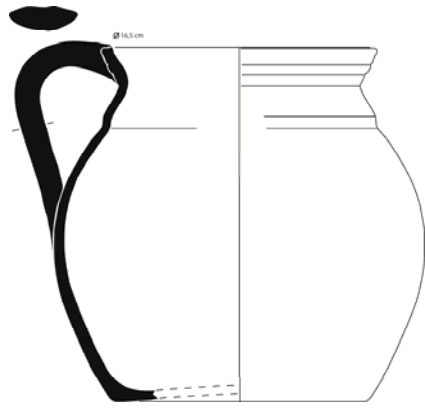
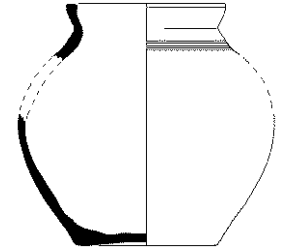

glazed inside

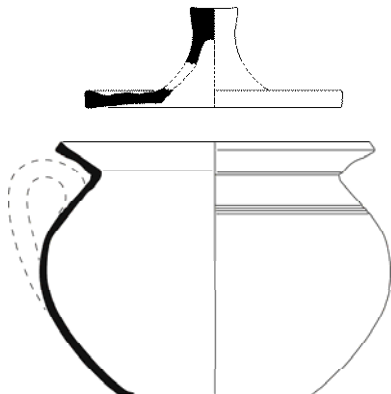
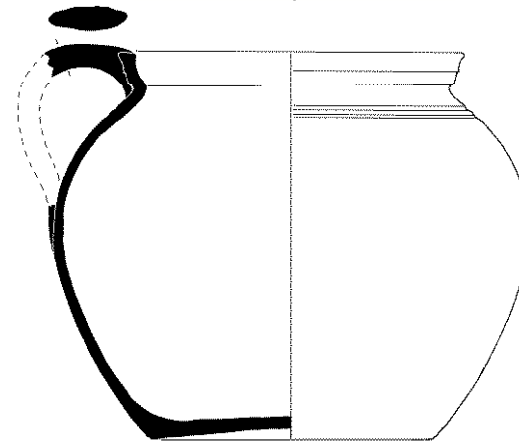

V = 2 to 5/6l, max 9l

## ● Food preparation

### ● Cooking pottery: pots

19th century

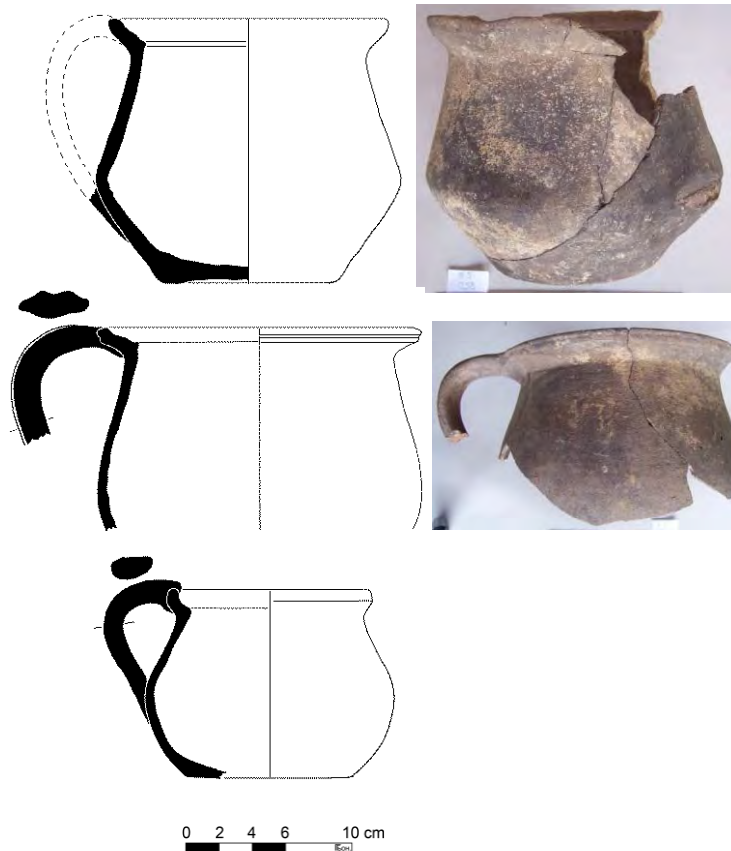

**Notary inventories 18th-1st ½ 19th century :**

- more than half of the inventories mention **copper or metal containers,**
- the average number by inventory is **3** when the number is stated
- generally, ceramic containers are mentioned only as product containers

**Postcards and paintings ca. 1900 :**  
rare earthenware pots



A. Mitov, 1917



Sofia, Jiten Pazar, ca. 1900

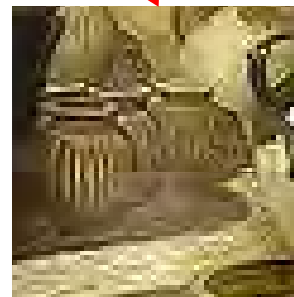

● Food preparation

● Cooking pottery: dishes or pans

late 16th century



0 2 4 6 10 cm

16th-17th century

glazed inside

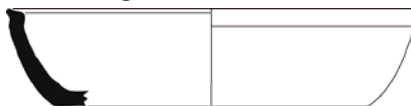

unglazed

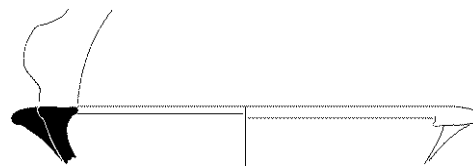
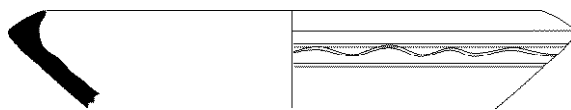
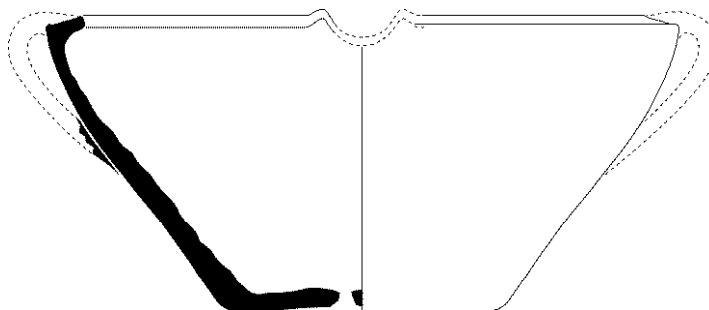
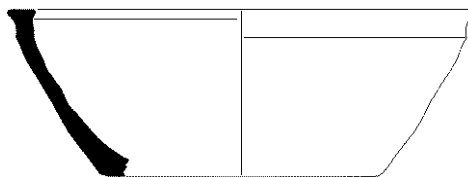

V = 2 to >51

18th century



19th century

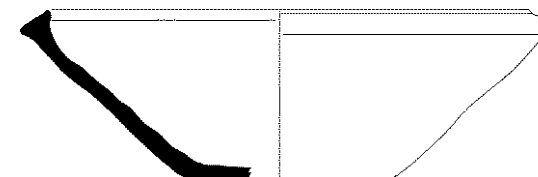



● Food preparation

● Cooking pottery: dishes or pans

**Notary inventories 18th-1st ½ 19th century :**

- 18<sup>th</sup> : 15 of 63 inventories, special mention metal (?) « **dishes** » in addition to **copper or metal containers**,
- 19<sup>th</sup> : no more metal (?) « **dishes** » but a lot of cooper containers



Sofia, Pl. Trapezitza, *ca.* 1900



Sofia, Jiten Pazar, *ca.* 1900



A. Mitov, 1917

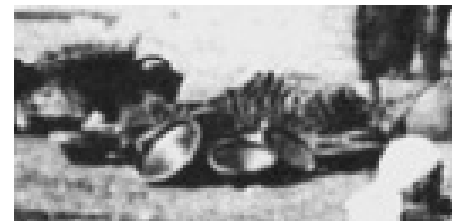

**Postcards and paintings *ca.* 1900 :**  
dishes are a common product



# ● Food preparation

- Preparation of meals: colander

late 16th century

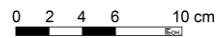
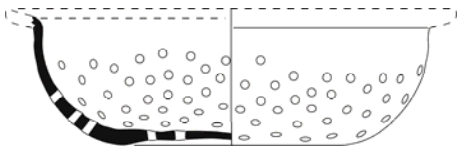

18th century

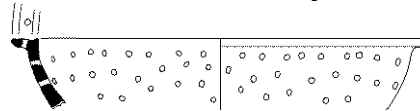

19th century

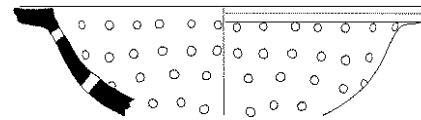
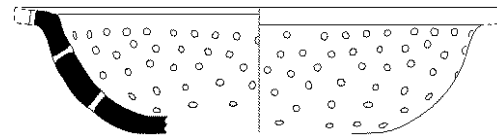

From late 16th to 19th century :  
rare but systematic

● Table service

● Cups and bowls

16th century

late 16th century

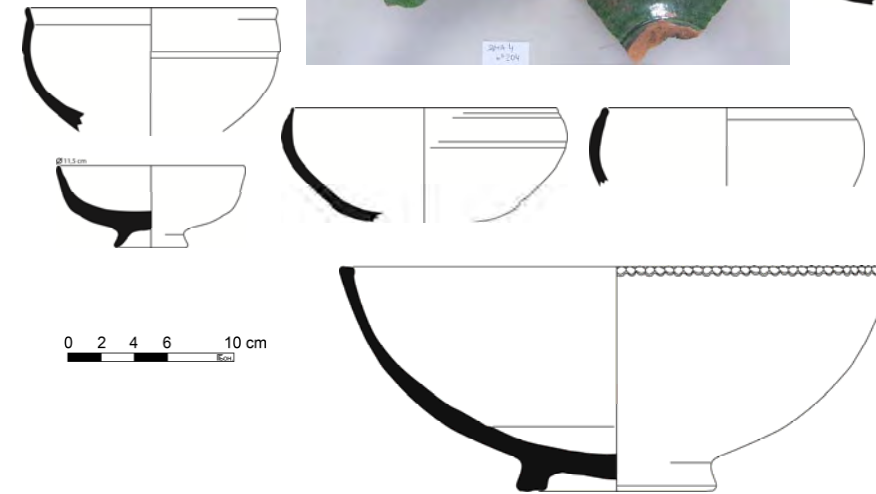
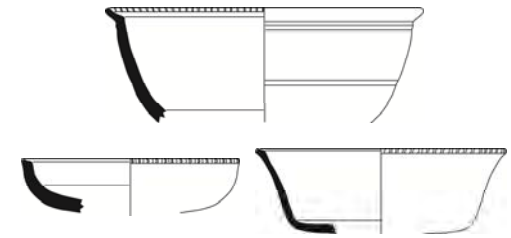
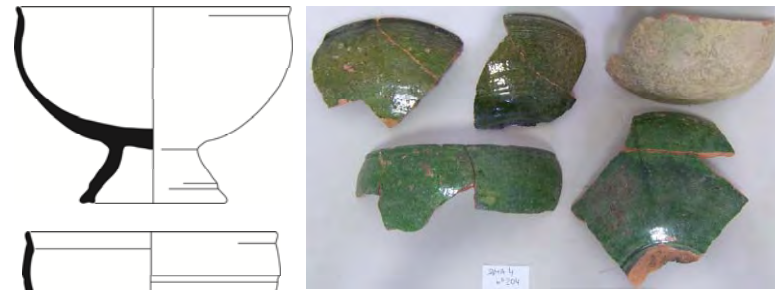
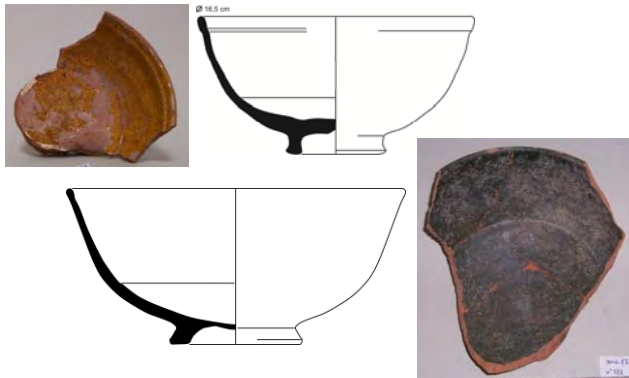

0 2 4 6 10 cm

D = 13 to 23cm

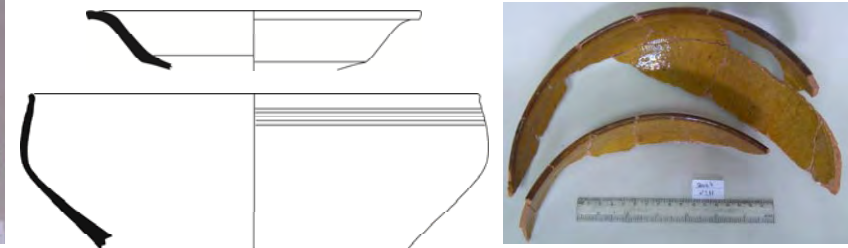
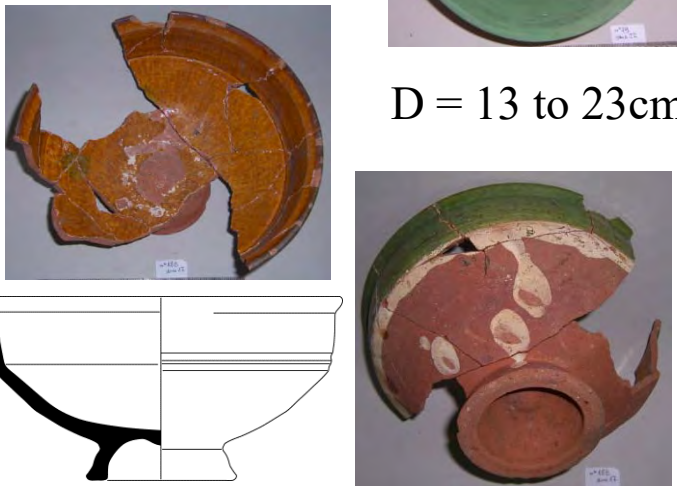

D = 10 to 35cm



● Table service

● Cups and bowls

16th-17th century

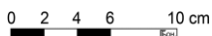
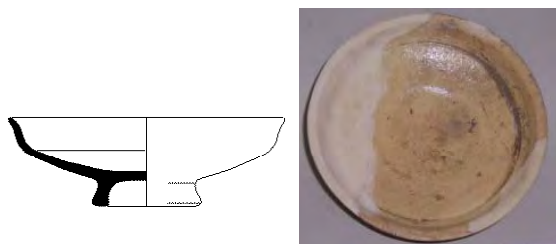
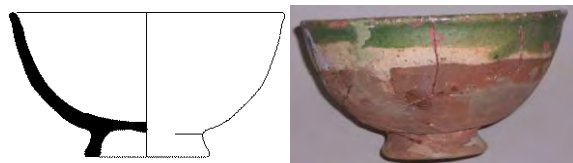

17th century

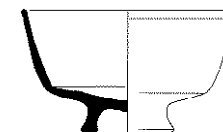
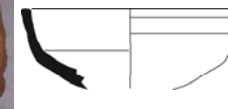
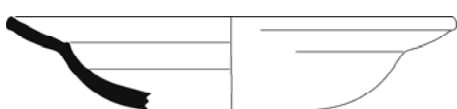

18th century

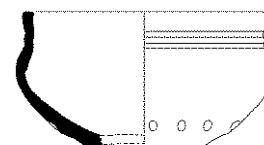
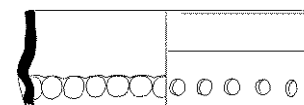
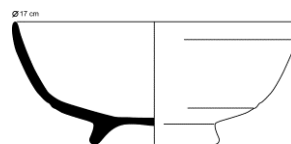

late 18th century

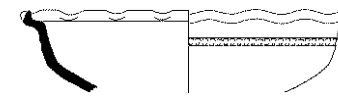

● Table service

● Cups and bowls

19th century

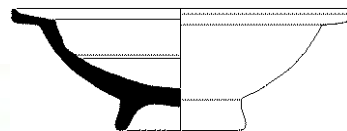
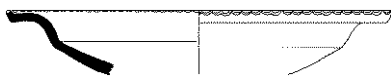
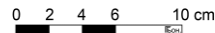
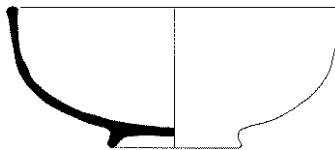
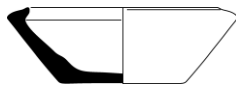
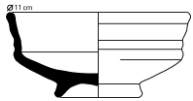
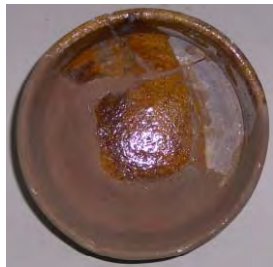
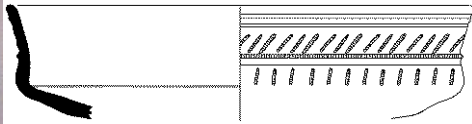

**Notary inventories 18th-1st ½ 19th century :**

- 18<sup>th</sup> : 1 (of 63) mention « plate »
  - 19<sup>th</sup> : 1 (of 37) mention « plates »
- => the tableware is not listed**



Sofia, ca. 1930



**Postcards and paintings  
ca. 1920 :**  
cups and bowls are a  
common product



Sofia, Janski Pazar, ca. 1930



A. Mitov, 1917



● Table service

● jugs and mugs for drinking

16th century



V = 0,4 to 1,2l

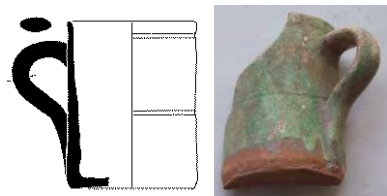

V = 0,2 to 0,3l

late 16th century



V = 0,4 to 1,2l

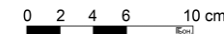

● Table service

● jugs and mugs for drinking

17th century

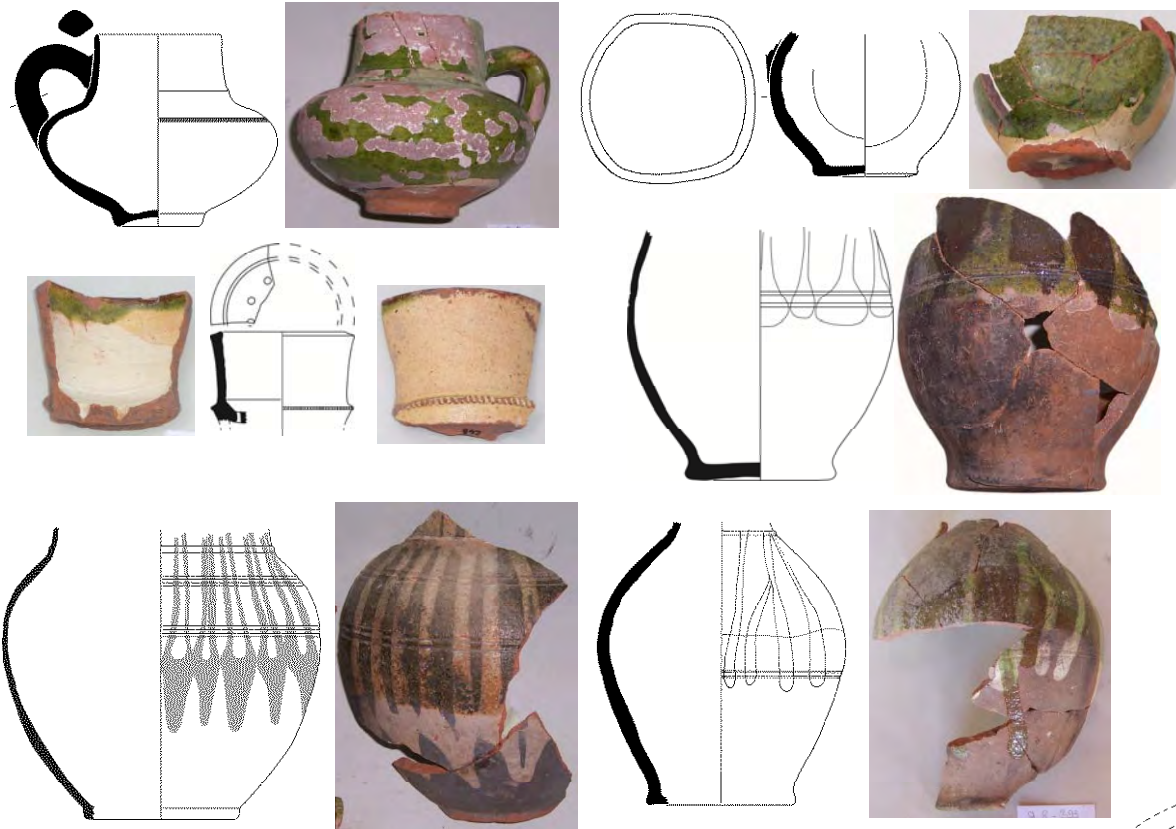

19th century

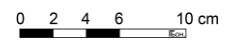
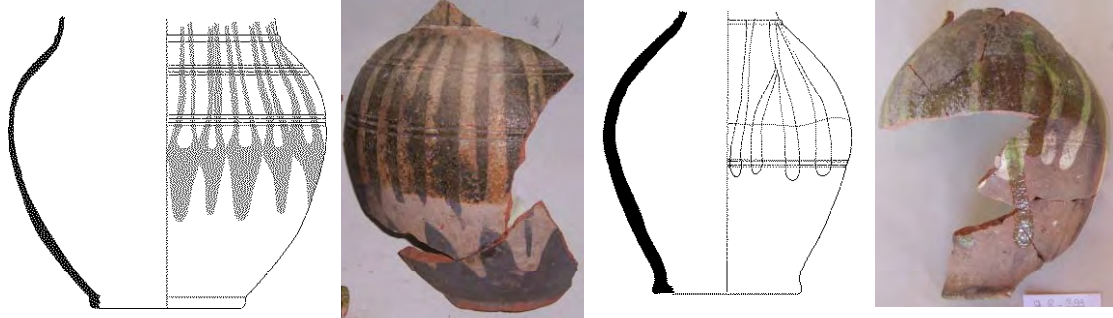

18th century

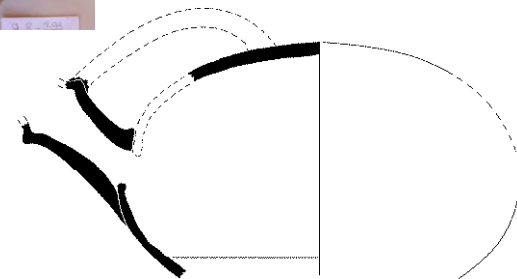
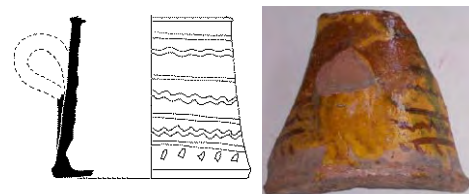



● Water storage

● transporting and heating water

16th century

17th century

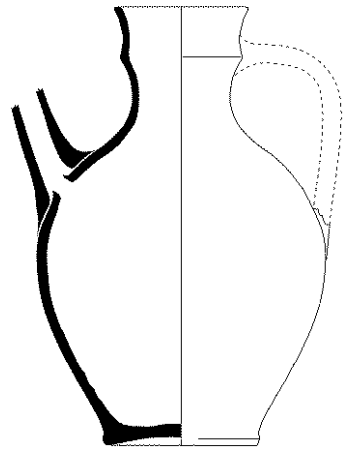
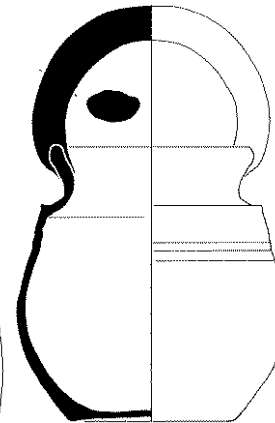
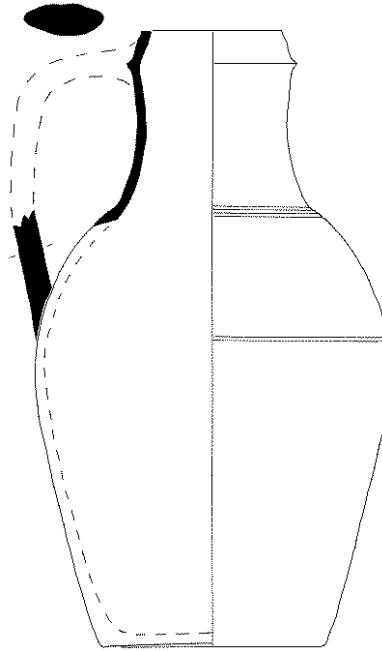
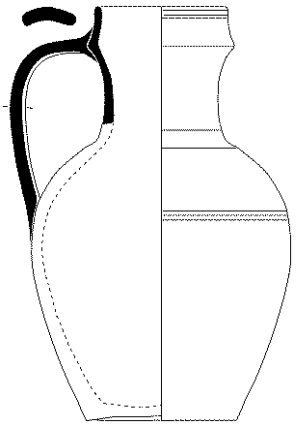

V = 5 to 7l

V = 2 to 3,5l

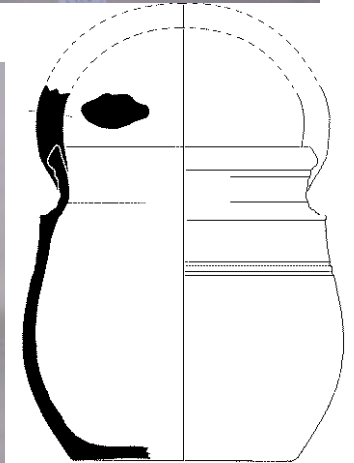

late 16th century

V ± 2,5l

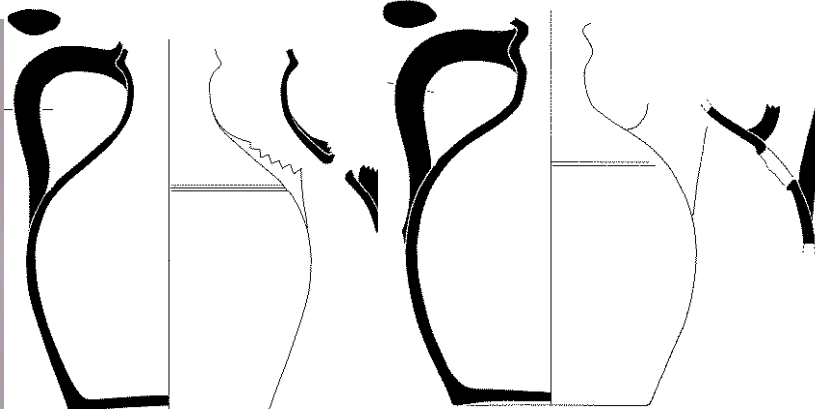



● Water storage

● transporting and heating water

19th century

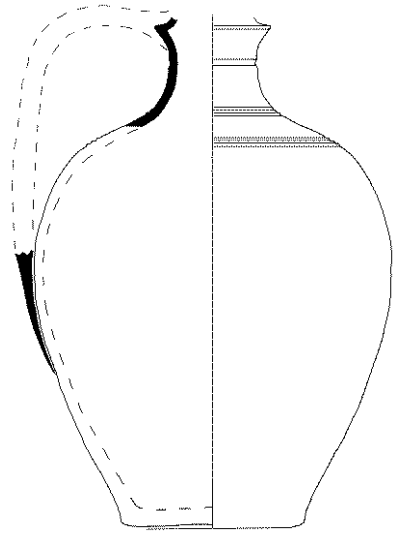

J. V. Mrkvička, At the well, 1906

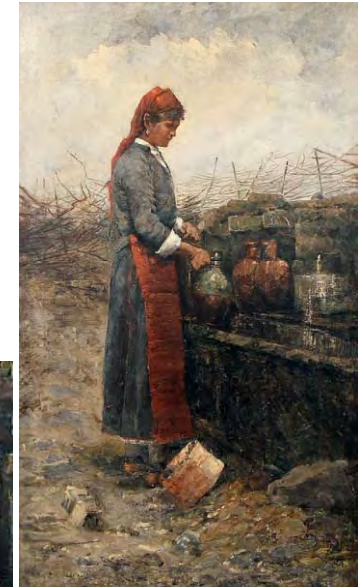

J. V. Mrkvička, At the fountain, 1873-1877

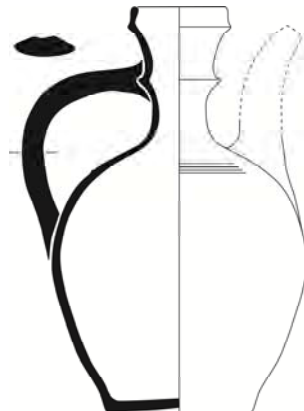
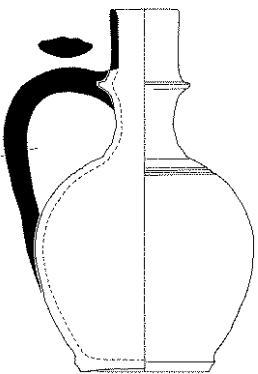

A. Mitov, At the fountain, 1899



A. Mitov, 1917

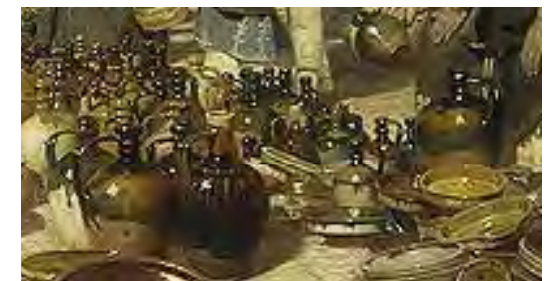

0 2 4 6 10 cm



# Consumption and conservation of drinks

Postcards and paintings  
ca. 1900-1930 :  
a lot of jugs and few **mugs**



Sofia, *boza* sellers ca. 1900



Sofia, Jiten Pazar, ca. 1900



Sofia, ca. 1917



Sofia, Jensi Pazar, ca. 1930

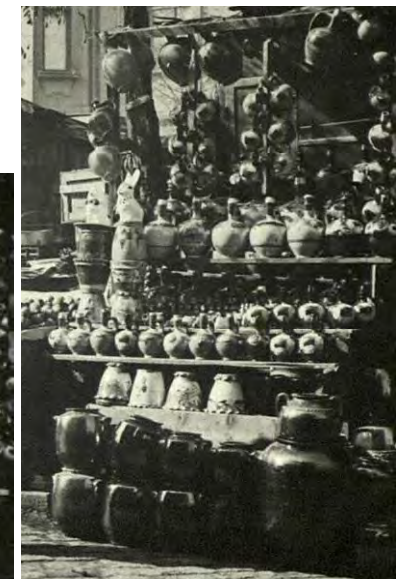

Sofia, Jensi Pazar, ca. 1930



Sofia, ca. 1920





# ● Preserving foodstuffs

● jars

16th-17th century :

late 16th century :

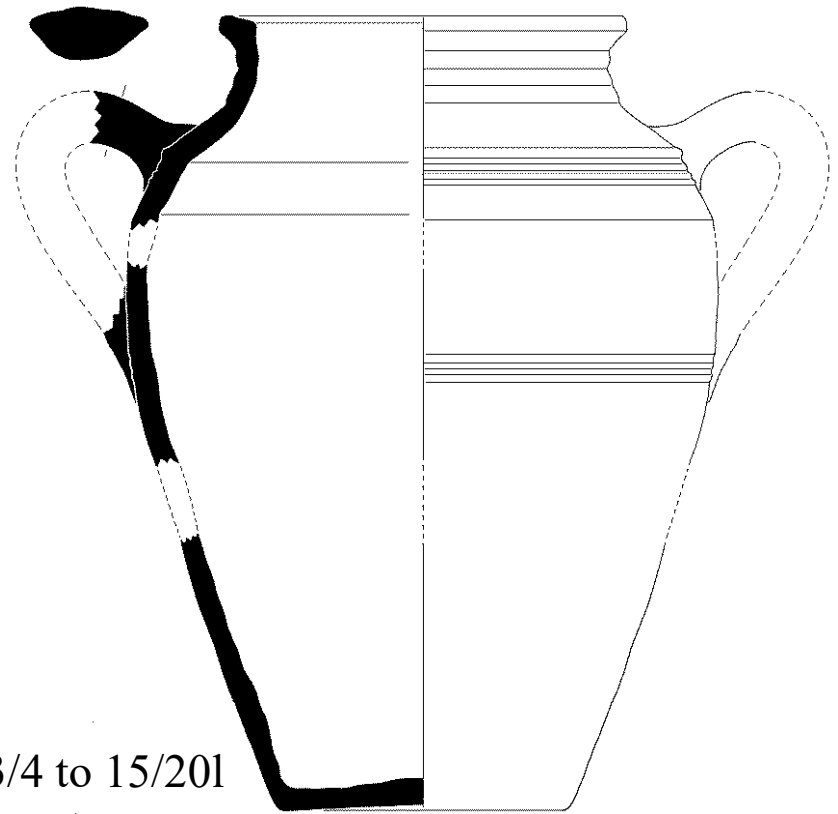
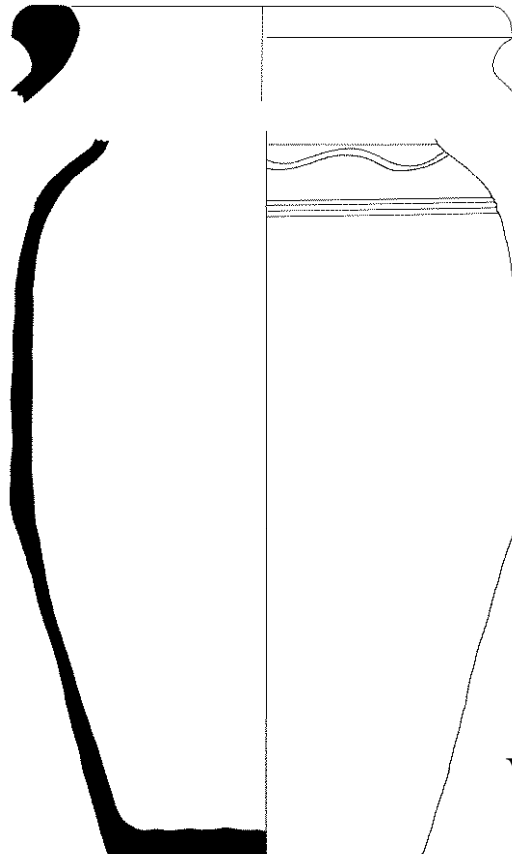

V = 3/4 to 15/201

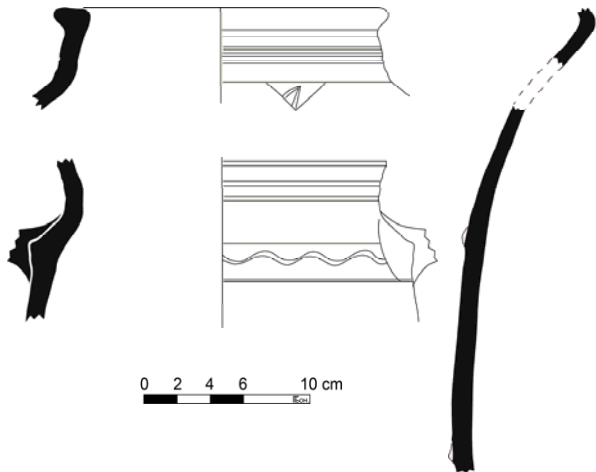



## ● Preserving foodstuffs ● jars

19th century

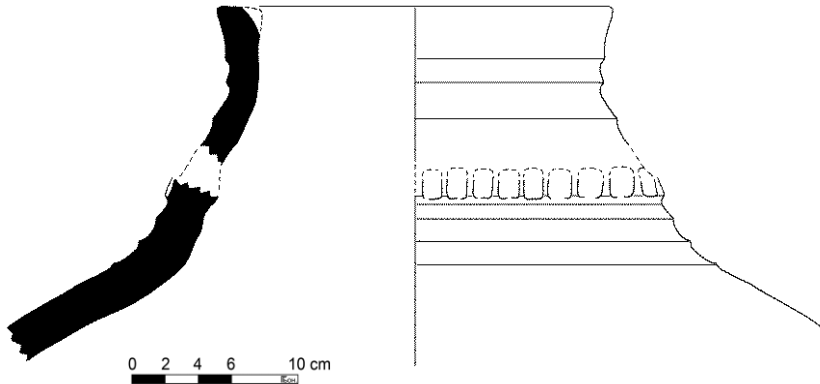

Sofia, ca. 1920



Sofia, Jenski Pazar, ca. 1930



### Notary inventories 18th-1st ½ 19th century :

- frequent mentions of big (wooden) containers
- pottery is never specially mentioned

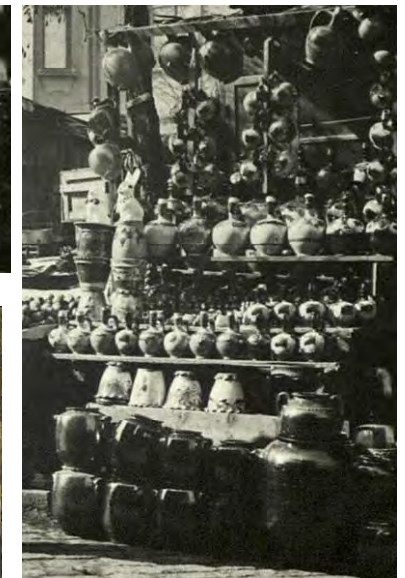
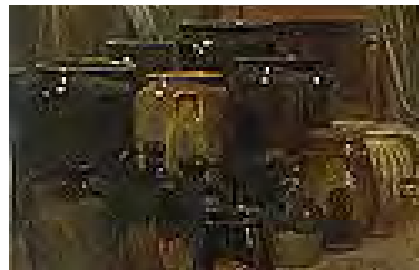

Sofia, Jenski Pazar, ca. 1930

**Postcards and paintings :**  
common product on the markets  
from the 20-30's of the 20<sup>th</sup> century



A. Mitov, 1917

## ● Hygiene

## ● chamber pots

16th century



late 16th century



17th-19th century :  
**no examples**

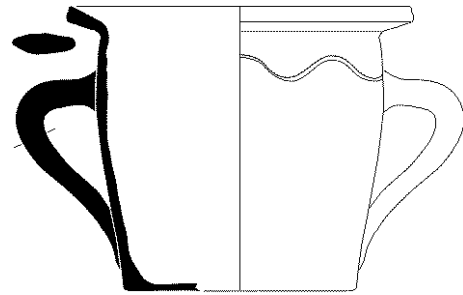

**Notarial inventories 18th-1st ½ 19th century :**

- 17 of 100 mention « **basin** » (some of them in copper)
- 14 of 100 mention « **ibriq** » (some of them in copper)

**=> often combined, toilet trim ?**

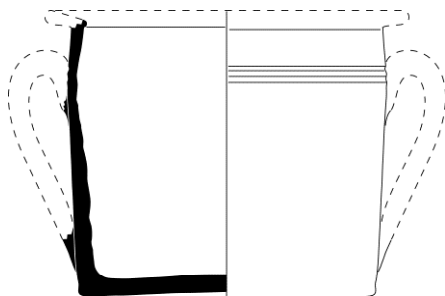

**Postcards and paintings ca. 1900 :**

The hygienic earthenware shapes are not present

0 2 4 6 10 cm



● Lighting

● candlestick

16th-17th century :  
**no examples**

**Notary inventories 18th-1st ½ 19th century :**

- 18<sup>th</sup> : 10 (of 63) mention « candlestick »
  - 19<sup>th</sup> : 2 (of 37) mention « candlestick »
- => **material?, metal?**

**Postcards and paintings ca. 1900 :**

The candlesticks are not present (or not visible)

18th century

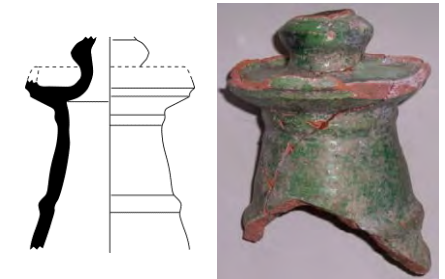

19th century

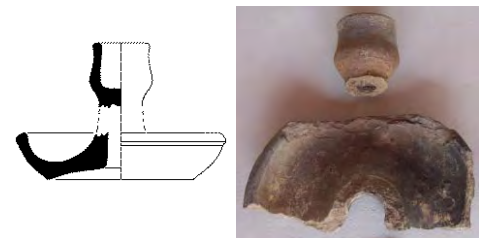

0 2 4 6 10 cm

● Heating

● stove tiles

19th century

late 16th-17th century :

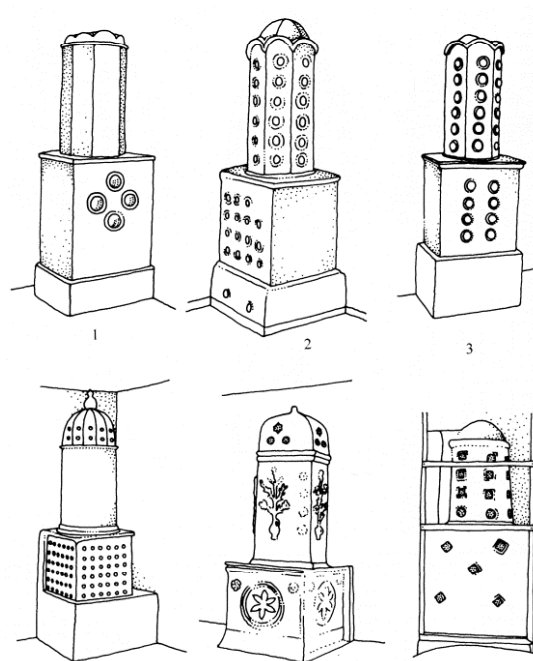

After <sup>4</sup>BAKARJIEF 1956, 54-60<sup>6</sup>



## ● Heating

### ● braseros

18th-19th century :

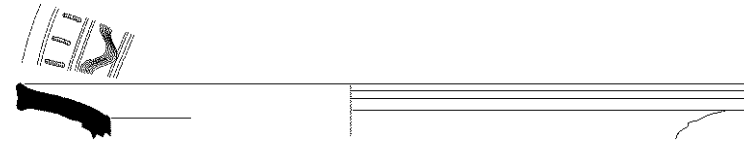
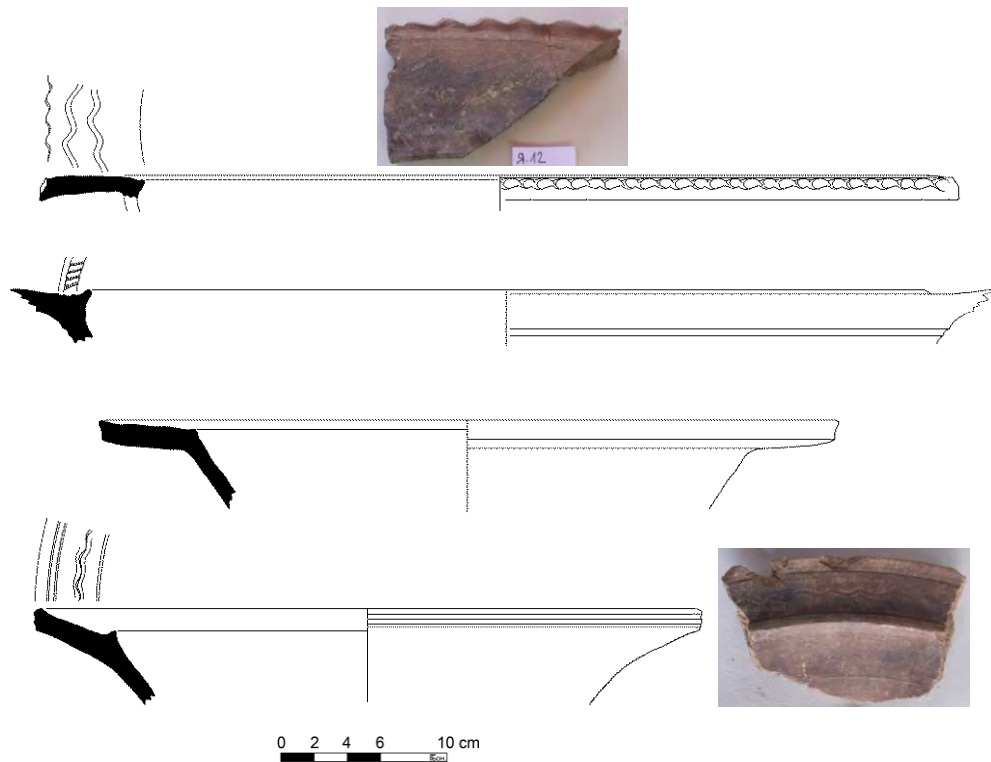

D = 45 to 55cm

**Notary inventories 18th-1st ½ 19th century :**

- 4 (of 100) mention « **brasero** »
- 1 of 4 mentions specifies « **copper** »



Earthenware brasero,  
Samokov, 19th century



Earthenware brasero,  
Museum of Samokov, 19th century



Copper brasero,  
Museum of Goce Delchev, 19th century

Decorating

flower pots

"second life"

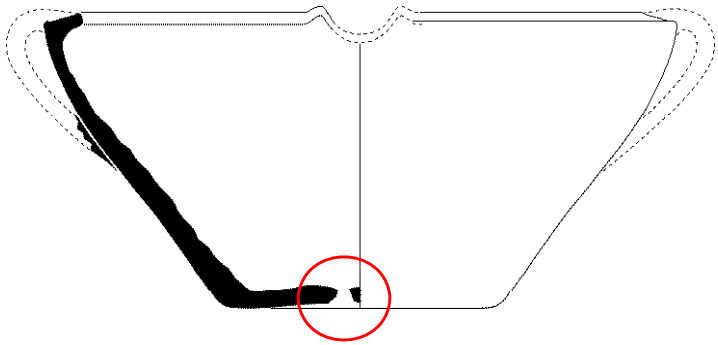

17th century :

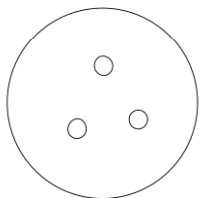
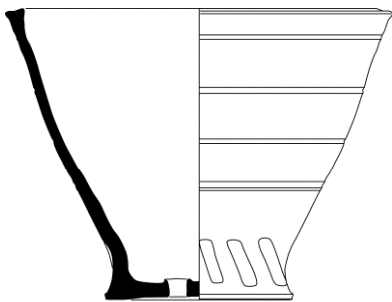
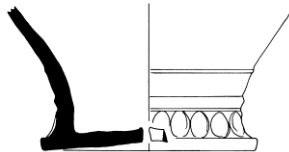

0 2 4 6 10 cm



Sofia, Jensi Pazar, ca. 1930



A. Mitov, 1917



Sofia, Jensi Pazar, ca. 1930

Postcards and paintings :  
on the markets from the 20-30's  
of the 20<sup>th</sup> century



● Other functions... an idea ?

19th century

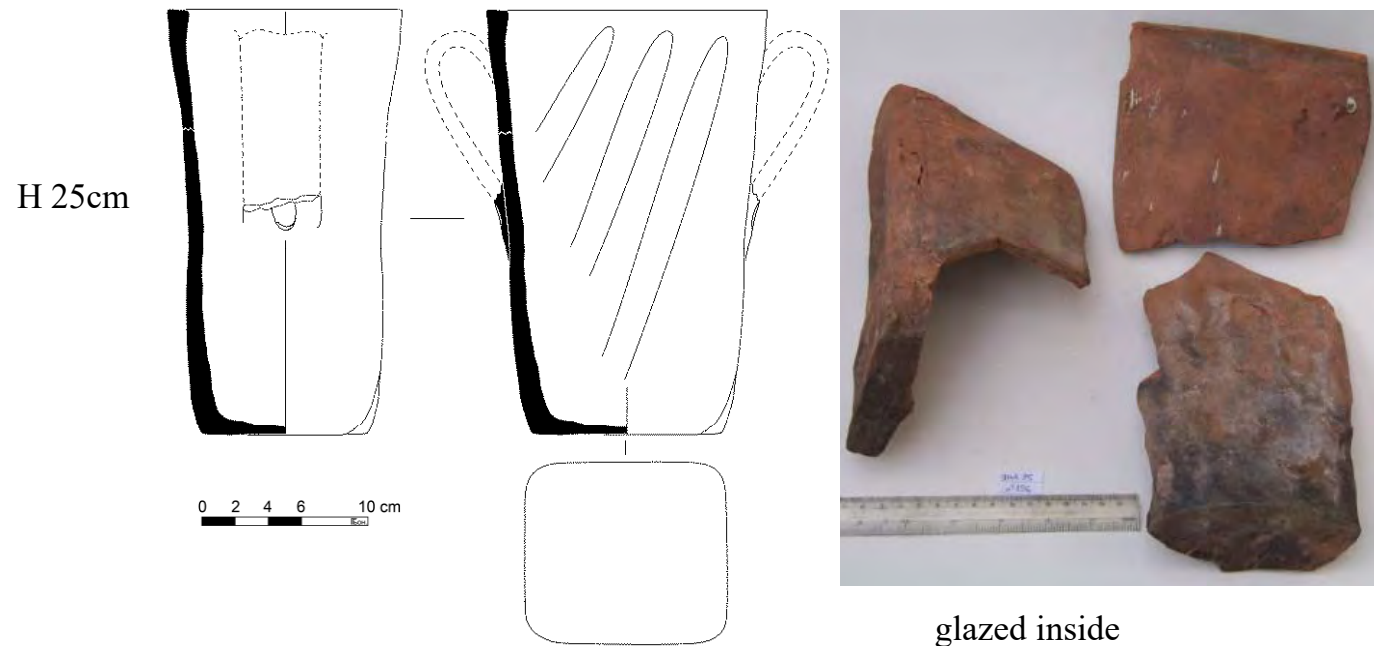

Other containers, other materials



wood



cheese seller



wickerwork



yaourt seller



copper



Thank you for your attention!

