



HAL
open science

The left edge of the word in the Berber derivational morphology

Mohamed Lahrouchi

► **To cite this version:**

Mohamed Lahrouchi. The left edge of the word in the Berber derivational morphology. *Glossa: a journal of general linguistics* (2016-2021), 2018, 3 (1), 10.5334/gjgl.250 . halshs-01774432

HAL Id: halshs-01774432

<https://shs.hal.science/halshs-01774432>

Submitted on 23 Apr 2018

HAL is a multi-disciplinary open access archive for the deposit and dissemination of scientific research documents, whether they are published or not. The documents may come from teaching and research institutions in France or abroad, or from public or private research centers.

L'archive ouverte pluridisciplinaire **HAL**, est destinée au dépôt et à la diffusion de documents scientifiques de niveau recherche, publiés ou non, émanant des établissements d'enseignement et de recherche français ou étrangers, des laboratoires publics ou privés.

RESEARCH

The left edge of the word in the Berber derivational morphology

Mohamed Lahrouchi

SFL – CNRS, Université Paris 8, 59 rue Pouchet, 75017 Paris, FR
mlahrouchi@univ-paris8.fr

In many Berber varieties, causative and reciprocal verbs are built by means of monoconsonantal prefixes attached to a stem. These prefixes are realized as single or geminated depending on the properties of the stem. In this paper, it is argued that an initial templatic site is responsible for the length variation of the prefixes. Under specific licensing conditions, the initial site hosts the causative and the reciprocal prefixes by means of two distinct operations, namely movement and spreading. Moreover, complex combinations of those prefixes (causative + reciprocal, reciprocal + causative) feed apparently unrelated phenomena of selective harmony and dissimilation. They are argued to follow directly from the use of the initial site as part of the verb domain. Handled in syntactic structure, the initial site further allows accounting for the cooccurrence restrictions that the causative and the imperfective markers undergo: it is proposed that the causative takes precedence over the imperfective because it is generated lower in the structure under the vP. The same reasoning holds for the incompatibility of imperfective gemination with the reciprocal marker. It is precisely this type of restrictions that strictly phonological analyses fail to address.

Keywords: Causative; reciprocal; harmony; templates; Berber

1 Introduction

In Berber, the causative and the reciprocal prefixes are realized as single or geminated depending on the properties of the verb. The examples in (1) illustrate the phenomenon in Tashlhiyt Berber:

(1)	a.	<i>Verb</i>		<i>Causative</i>	
		mun	‘be picked up’	s-mun	‘pick up’
		gawr	‘sit’	s-gawr	‘seat’
		knu	‘lean’	ss-knu	‘tilt’
		xdm	‘work’	ss-xdm	‘make someone work’
	b.	<i>Verb</i>		<i>Reciprocal</i>	
		ḥsad	‘be jealous’	m-ḥsid	‘be jealous of each other’
		ʃnnq	‘strangle’	m-ʃinniq	‘strangle each other’
		zri	‘pass by’	mm-zri	‘meet each other’
		rwi	‘mix’	mm-rwi	‘mingle, mix with each other’

The reader will have noticed that the vowels of the base form remain the same in the causative, whereas in the reciprocal they can be replaced by an invariant vocalic melody inserted after the first and before the last root consonants (/i...i/ in the aorist, /a...a/

in the preterit).¹ In addition, the distribution of vowels in the verb appears to play an important role in the choice of the prefix variant: verbs beginning with a CV sequence select the simplex variant of the prefix, while those that begin with two consonants take the geminated variant.

Complex combinations of these prefixes result in forms where only the inner prefix varies in length. As shown in the examples in (2), the causative prefix remains simplex, while the reciprocal prefix surfaces as single or geminated.

(2)	<i>Verb</i>		<i>Causative + Reciprocal</i>	
	ɣawn	'help'	s-m-ɣiwin	'make (them) help each other'
	ħada	'be beside'	s-m-ħidi	'make close to each other'
	knu	'lean'	s-mm-knu	'make lean mutually'
	rwi	'soil'	s-mm-rwi	'make soil each other'

Interestingly enough, these verbs are restricted in the way they form their imperfective. While base verbs use either gemination or tt-prefixation to mark the imperfective, causative and reciprocal verbs invariably resort to vowel insertion. For instance, [smmrwi] forms its imperfective as [smmrwaj], while the base verb [rwi] geminates the medial consonant. Similarly, [smħidi] leads to imperfective [smħadaj], whereas [ħada] uses tt-prefixation.

The cooccurrence restrictions that verbs like [smmrwaj] and [smħadaj] show actually follow from the incompatibility of the causative and the reciprocal prefixes with the imperfective markers. The causative forms in (3) further illustrate the interaction with the imperfective.

(3)	<i>Verb</i>		<i>Imperfective</i>	<i>Imperfective + Causative</i>
	gawr	'sit'	ttgawar	*ttsgawar
	xdm	'work'	ttxdam	*ttssxdam
	lkm	'arrive'	lkkm	*sslkkm
	ntl	'hide'	nttl	*ssnttl

Previous accounts of the length variation of the causative and the reciprocal prefixes focus on the phonological properties of the verb. Boukous (1987), Jebbour (1999) and Dell and Elmedlaoui (2002), among others, discuss prosodic constraints on the input or the output of the formation, but none of them has explicitly addressed complex forms of the types in (2) and (3). The analysis provided in this paper diverges from that trend. I claim that an initial templatic site is responsible for the length variation of the causative and the reciprocal prefixes. Moreover, complex combinations of these prefixes are argued to follow from the implementation of the initial site as part of the verb domain. The cooccurrence restrictions the causative, the reciprocal and the imperfective markers display will be analysed at the interface between phonology and syntax, claiming that these markers compete for the same templatic position. It will be argued that the identification of this position obeys a syntactic hierarchy in which the causative and the reciprocal take precedence over the imperfective because they are generated lower in the structure under vP. This proposal might appear to steer against the standard analyses, which generally agree on the fact that competition does not necessarily hold

¹ This invariable vocalization preferably triggers verbs containing three consonants; biconsonantals and vowel-final verbs either keep their own lexical vowels (e.g. [knu] > [mmknu] 'lean', [rwi] > [mrrwi] 'soil') or undergo vowel insertion (e.g. [ls] > [mmlsu] 'wear', [ns] > [mmnsu] 'spend the night').

within syntactic structures, and that there is no reason for some syntactic categories to take precedence over other categories. It will be shown that templatic constraints are necessary in order to account for the cooccurrence restrictions of certain markers and the overt realisation of some morphosyntactic categories.

The paper is organized as follows: section 2 discusses earlier accounts of the length variation that the causative and the reciprocal prefixes display. Section 3 provides some theoretical background necessary for the understanding of the proposed analysis. A templatic account for the length variation of the causative and the reciprocal prefixes is presented in sections 4–6. Section 7 turns to the cooccurrence restrictions underlying the distribution of the causative, the reciprocal and the imperfective markers. Section 8 concludes the paper.

2 Earlier accounts of the quantity variation of the causative and the reciprocal prefixes

Most accounts of the length variation of the causative and the reciprocal prefixes in Berber are phonological as they rest on syllable and prosodic structure of the verb (cf. Boukous 1987; Iazzi 1991; Lasri 1991; Jebbour 1999; Lahrouchi 2001; 2003; Dell & Elmedlaoui 2002; Saa 2010). They state that the quantity variation of these prefixes depends on the phonological properties of the verb. Others such as Chaker (1973; 1984), Chami (1979) and Cadi (1987) examine the segmental environment of the prefixes, claiming that the non-geminated variants attach to verbs beginning with a consonant, while the geminated variants select verbs that begin with a vowel, including the short epenthetic [ə]. This section outlines the syllable-based analyses put forth in Jebbour (1999), Dell and Elmedlaoui (2002) and Saa (2010), as opposed to the templatic approach proposed in Guerssel (1992).

2.1 Syllable-based analyses

According to Saa (2010: 124), the causative prefix geminates when it is syllabified in the onset position (e.g. [ari] / [ssiri] ‘write’, [kkər] / [ssəkkər] ‘stand up’) or when it is adjoined to an underlying CC verb (e.g. /rs/ > [rəs] / [ssrəs] ‘put’, /xs/ > [xəs] / [ssxəs] ‘want’). Although it is not explicitly claimed, the author suggests that the prefix is underlyingly simplex. The same reasoning underlies the analysis put forth in Dell & Elmedlaoui (2002: 128). The quantity variation of the prefix depends, the authors argue, on the number of syllables the output contains. That is, the prefix geminates when the output form is left with less than three syllables. Otherwise, the prefix remains ungeminated. For instance, verbs like [frs] ‘bend’ and [ʃrg] ‘sweat’, which are monosyllabic according to the authors’ syllable model, select the geminated variant of the prefix. Similarly, [lkm] ‘arrive’ exhibits only two syllables, of which the first is onsetless. Its causative displays a geminated prefix, whose first half is syllabic while the second half attaches to the onset of the following syllable. This contrasts with verbs like [rufu] ‘be thirsty’ and [ngiri] ‘be separated’ for which it is not necessary to geminate the causative prefix to get the appropriate number of syllables. However, the analysis faces problems when it comes to explaining why verbs like [mun] ‘be picked up’ and [ruħ] ‘go home’ do not select the geminated variant of the prefix although they contain only one syllable, just like [frs] and [ʃrg] discussed above.

An alternative is provided in Jebbour (1999: 13). The author argues that the difference between verbs like [mun] and those like [frs] lies in their moraic rather than syllabic weight. The first select the simplex variant of the causative prefix because they are bimoraic, while the second, monomoraic, require a geminated prefix. The distribution of

the variants of the causative prefix ultimately lies on the distinction between monomoraic and polymoraic bases, regardless of the number of syllables: [frs] patterns with verbs like [nu] ‘be cooked’ and [yr] ‘read’, while [mun] patterns with verbs like [rufu] ‘be thirsty’ and [gusmu] ‘be full up’.

2.2 A templatic approach

In Ait Seghroushen Tamazight Berber, the causative prefix always surfaces as a geminate, except when preceded by another prefix such as the passive /ttu-/ and the reciprocal /m-/ (e.g. [ss-əfsi] ‘melt’ / [ttu-s-əfsi] ‘melt-passive’, [ss-əfhəm] ‘make understand’ / [m-s-əfhəm] ‘understand each other’, [ss-əxdəm] ‘make work’ / [m-s-əxdəm] ‘make each other work’). According to Guerssel (1992), the causative prefix is simplex in the underlying representation. Its gemination follows from the presence of an abstract verbal morpheme, made of an empty Onset and an empty Nucleus. The example represented in (4) illustrates the proposal.

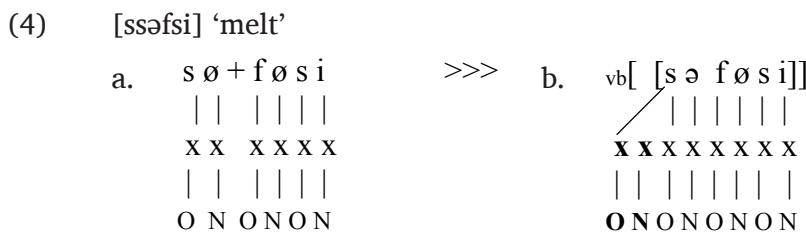

The form in (4a) constitutes, according to the author, an “open expression” which is grammatically unspecified. It is the abstract initial morpheme (in bold) that assigns this expression the feature [+verb]. It also allows the causative prefix to geminate by spreading into the empty initial onset (4b).

The analysis I will be developing in this paper differs in many respects from the one advocated in the case of Ait Seghroushen Tamazight. While I endorse the idea of an empty templatic site, I will argue that its activation is not automatic. Rather, it depends on the phonological properties of the verb stem, and more particularly on the ability of the following vowel to license the empty site. This will be shown necessary in order to account for the length variation of the causative morpheme in the Berber varieties studied here, as opposed to the Ait Seghroushen variety in which this morpheme is always geminated. The licensing status of the empty site will also allow to explain how complex combinations of the causative and the reciprocal morphemes result in forms where only the inner prefix varies in length while the outer one remains simplex (e.g. Tashlhiyt [s-mm-knu] ‘make lean mutually’ / [s-m-ħidi] ‘make close to each other’), contrary to Ait Seghroushen Tamazight where it is the inner prefix that remains constantly simplex (e.g. [mm-zraj] ‘leave each other’ / [ss-m-zraj] ‘cause to leave each other’, [mm-xmaz] ‘scratch each other’ / [ss-m-xmaz] ‘cause to scratch each other’). Moreover, it will be argued that both causative and reciprocal prefixes have access to the empty initial site, unlike the analysis proposed by Guerssel which makes the site available only to the causative prefix, considered to be acategorical, as opposed to the reciprocal morpheme.

In the remainder of this paper, I will try to describe more explicitly the templatic mechanism responsible for the length variation of the causative and the reciprocal morphemes in many Berber varieties, including Tashlhiyt, Kabyle and Tarifit. I will argue that an item-by-item computation is necessary to determine the way the empty initial site is activated in these varieties. To do so, I need to outline the main assumptions about the representation of the skeletal tier and the syllable structure in the framework adopted here.

3 Theoretical background

3.1 CVCV model

As an offshoot of Government Phonology (Kaye et al. 1990), the CVCV model (Lowenstamm 1996) holds that syllable structure universally reduces to strict alternations of non-branching constituents, viz. onsets (C positions) and nuclei (V positions), which interact laterally to derive various syllable types (see also Scheer 2004). Skeletal positions that have no phonetic content are said to be licensed to remain empty by virtue of the government relation that they share with the neighbouring segments. *Proper Government* is one such relation which allows a vocalic position to remain empty when followed by a vowel. In addition, it is assumed following Kaye (1990: 314) that domain-final V positions are parametrically licensed to remain empty despite being ungoverned. This proves particularly interesting in analysing the vowel/zero alternations found in Berber varieties other than Tashlhiyt. The examples in (5) illustrate the situation in Tamazight Berber:

- (5) a. [kʃəm] ‘enter – imperative 2.SG’ b. [kəʃmat] ‘enter – imperative 2.PL’

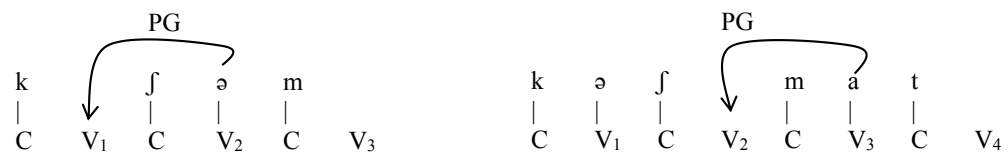

In (5a), domain-final V_3 remains empty. V_2 , properly ungoverned surfaces as [ə] and therefore governs V_1 , leading to the form [kʃəm]. This contrasts with [kəʃmat] in (5b) where V_2 , properly governed by the vowel /a/, remains empty while V_1 surfaces as schwa. The reader is referred to Bendjaballah (2001: 188) and Ben Si Said (2014) for similar facts in Kabyle Berber.

In Berber varieties where no epenthetic schwa is found, syllabic consonants arise. Any vocalic position lacking proper government systematically hosts one syllabic consonant (cf. Blaho 2004 and Scheer 2008 on Slavic; Beltzung & Patin 2007 on Coptic; Hammane 2010 on Tashlhiyt). To illustrate this, let us consider the verbs [kʃəm] and [kəʃmat] just discussed in Tamazight Berber. In Tashlhiyt, no epenthetic vowel appears in the surface form of these verbs. Accordingly, in [kʃm] (6a) the consonant /m/ fills the V position to its left and then governs the empty V between /k/ and /ʃ/, whereas in [kʃmat] (6b) it is the consonant /ʃ/ that branches into the preceding ungoverned V position.

- (6) a. [kʃm] ‘enter – imperative 2.SG’ b. [kʃmat] ‘enter – imperative 2.PL’

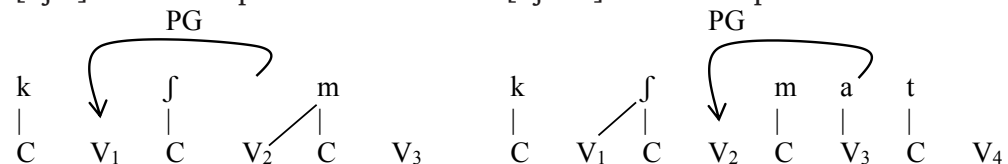

The left-branching representation is supported by the distribution of epenthetic vowels in Berber varieties where only vocalic elements appear in the nucleus position, including the aforementioned Tamazight variety. Indeed, the careful reader will have noticed that the syllabic consonants in the Tashlhiyt forms in (6) are exactly the ones preceded by an epenthetic schwa in Tamazight (5). Further evidence is found in languages such as German (Clark & Yallop 1995: 68), Dutch (Oostendorp 2004), and Coptic (Beltzung & Patin 2007), where many instances of əC are in complementary distribution with syllabic C (e.g. German [ha:bən] ≈ [ha:b̥m] ‘to have’, [ge:bən] ≈ [ge:b̥m] ‘to give’, [daŋkən] ≈ [daŋk̥ŋ] ‘to thank’; Coptic [ʃnto] ≈ [ʃənto] ‘robe (of linen)’, [solp] ≈ [soləp] ‘to break’).

In these examples, the initial CV is licensed by the vowel /a/. In (8b), the obstruent and the liquid form a closed domain (in brackets) inaccessible to proper government, which allows the following vowel to license the initial site.² As a consequence, the definite articles *le*, *les* and *l'* attach directly to the initial CV. This is illustrated in the forms on the right side in (8).

Biblical Hebrew differs from French in that it has surface sequences of obstruents and liquids at the beginning of the word and their mirror-image (e.g. [qraβim] ‘midsts’ vs. [rqahim] ‘spices’, [klaβim] ‘dogs’ vs. [lxaðim] (< /lkadim/) ‘captures’). These sequences, which result from syncope of the initial vowel of the singular form according to Lowenstamm (1999: 159), allow considering the initial site in Biblical Hebrew as not always licensed. It is expected to host proclitics in words like [klaβim] but not words like [rqahim]. In fact, the initial site is used in both types of words, the author argues. In the first type, the vowel of the definite article /ha/ spreads into the V position of the initial site, while in the other it is the stem-initial consonant that spreads. This is shown in (9):

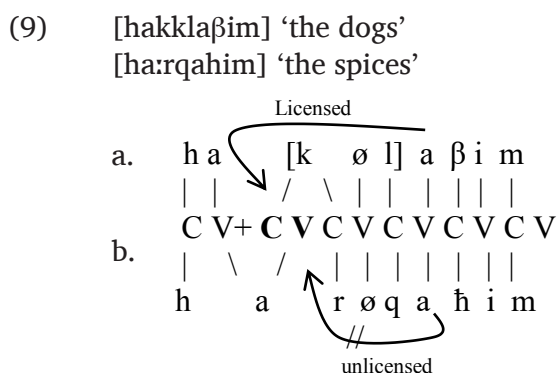

According to Lowenstamm (1999: 164), a uniformity convention allows the initial CV to remain unlicensed throughout the language, even in words beginning with sonority-rising clusters. Vowel lengthening in [ha:rqahim] and consonant gemination in [hakklaβim] are viewed as the result of the identification of a templatic site which may not remain silent inside the phonological domain of the word. It should be noted, however, that lengthening of the definite article’s vowel occurs only when consonant gemination fails, that is when the initial consonant belongs to the class of consonants which resist gemination.³

An attempt is made in this paper to pinpoint a third type of languages (Berber), in which the initial site is not always licensed and its identification operates item by item.⁴ I will argue that the causative and the reciprocal morphemes either *spread* or *move* into the initial site, depending on its licensing status. Moreover, complex combinations of these prefixes and apparently unrelated phenomena of selective (dis)harmony will be shown to follow directly from the presence of the initial site.

² Following the proposal put forth in Scheer (1996), Lowenstamm assumes that in French a word-initial sequence consisting of an obstruent followed by a liquid constitutes a closed domain that the following vowel straddles to license the initial site (see also Scheer 2004: 101–102). An alternative to this proposal is found in Lowenstamm (2003: 354–360).

³ Scheer (2004: 111) and Seigneur-Froli (2001: 62–69; 2003: 354; 2006: 278) take a different view of the problem. Relying on similar facts in Czech and Greek, they suggest that the dichotomy that opposes languages with clusters of rising sonority at the beginning of the word to languages where such clusters are made sonority-free is a matter of presence vs. absence of the initial site, rather than a difference in the licensing status. They claim that languages like English and French with sonority-rising clusters have an initial site, whereas languages with sonority-free clusters do not.

⁴ Lowenstamm (1999: 164; footnote 10) rightly acknowledges that languages in which checking of the licensing status of the initial site operates item by item is “an option that cannot be ruled out in principle”.

4 Length variation of the causative and reciprocal prefixes

4.1 Causative forms

In many Berber varieties, the causative prefix is realized single or geminated depending on the properties of the stem. Generally-speaking, the prefix is single when attached to a stem that begins with a consonant-vowel sequence. It is geminated when attached to a stem beginning with a CC cluster. The examples in (10) illustrate the situation in Tashlhiyt Berber.⁵

(10)	<i>Verb</i>		<i>Causative</i>	
a.	mun	'be picked'	smun	'pick up'
	faw	'be lit'	sfaw	'light'
	gudi	'be in a pile'	sgudi	'put in a pile'
	mijjl	'bow'	smijjl	'tilt'
	gawr	'sit down'	sgawr	'seat'
b.	knu	'lean'	ssknu	'tilt'
	rku	'be dirty'	ssrku	'soil'
	rmi	'be tired'	ssrmi	'tire'
	xdm	'work'	ssxdm	'make work'

The same situation holds in Tarifit Berber and Kabyle, as shown in the examples in (11) and (12).

(11) Tarifit Berber (Cadi 1987)

	<i>Verb</i>		<i>Causative</i>	
a.	bədd	'get up'	sbədd	'get someone up'
	qas	'taste'	sqas	'make taste'
	ħəjjəq	'be displeased'	shəjjəq	'displease'
b.	qdʰəf	'be sharp'	ssəqdʰəf	'sharpen'
	kkar	'stand up'	ssəkkar	'lift someone up'
	qrʊʒʒəf	'tumble down'	ssəqrʊʒʒəf	'make tumble'
	krumbəf	'be buckled, curl'	ssəkrumbəf	'buckle'

(12) Kabyle (Nait-Zerrad 1994)

	<i>Verb</i>		<i>Causative</i>	
a.	məd	'be sufficient'	sməd	'give enough'
	gən	'sleep'	sgən	'put to bed'
	luɣ	'be cloudy'	sluɣ	'make cloudy'
	laqəb	'scoff at'	sliqəb	'ridicule'
b.	fruri	'be crumbled'	ssəfruri	'crumble'
	kʃəm	'enter'	ssəkʃəm	'introduce'
	ndəkwal	'get better'	ssəndəkwal	'revive'
	ħfədʰ	'learn'	ssəħfədʰ	'teach'

Tashlhiyt differs from Tarifit and Kabyle in that it does not resort to vowel epenthesis to break up consonant clusters. Rather, it allows any kind of segments, including voiceless

⁵ Tashlhiyt, Tarifit and Kabyle belong to the Berber group of languages spoken in the Northern part of Africa. Tashlhiyt is spoken in Southwest Morocco, Tarifit in Northern Morocco, and Kabyle in Northeast Algeria.

obstruents, to be syllabic (cf. Dell & Elmedlaoui 1985; 2002; Ridouane 2008). This feature will be shown to be of paramount importance in determining the status of the initial site, and therefore the size of the causative and reciprocal prefixes in verbs with no peripheral vowels. Before turning to this issue in section 4.3, let us show how the size variation of the causative prefix obtains in Tarifit and Kabyle. This variation follows directly, I argue, from the status of the initial CV with regard to licensing.

In Berber, the initial site may be activated by means of two operations, namely *movement* and *spreading*. This is in contrast to French and Hebrew where only one of the two operations may be implemented. Movement occurs when the initial site is licensed by the following vowel, as opposed to spreading which is viewed as the result of the identification of a templatic site which may not remain empty inside the phonological domain of the word (see Hebrew in (9)).

The quantity variation of the causative prefix in the examples in (11) and (12) follows directly from the use of one or the other of the operations just mentioned. According to the present analysis, the causative prefix is underlyingly simplex. Its quantity variation depends on the way the empty initial site is activated:

- (13) (i) /s/ moves into the initial site when it is licensed, that is properly governed by the following vowel.
 (ii) It geminates by spreading into the empty site when it is unlicensed.

The causative forms represented in (14) and (15) illustrate both situations.

(14) Tarifit Berber

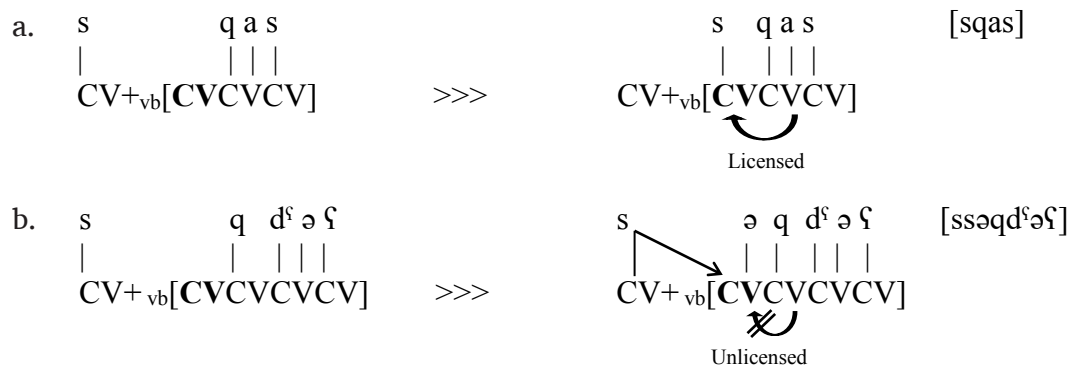

(15) Kabyle

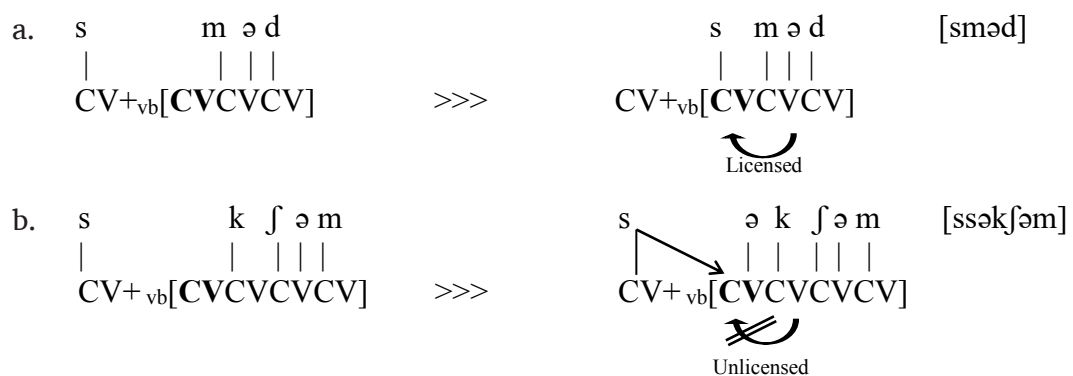

As stated previously in this section, the initial CV (in bold) cannot remain empty inside the domain of the verb (bracketed). The forms in (14a) and (15a) illustrate the case where

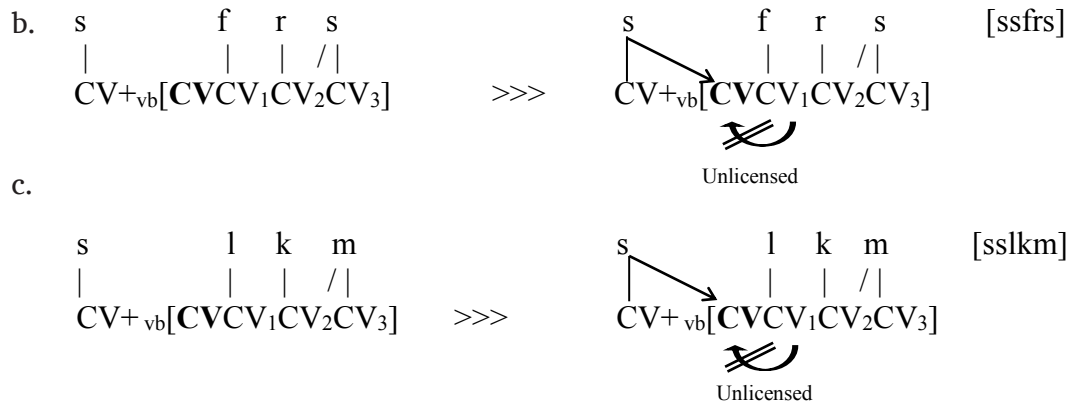

In (23a), V_4 remains empty by virtue of being domain-final. V_3 , properly ungoverned is filled by the neighbouring consonant and therefore governs V_2 . V_1 , just as V_3 , allows the syllabic consonant to branch and then licenses the initial CV, leading to a situation where the prefix *s-* can move into its C position. This contrasts with the situation in (23b) and (23c) where V_2 , properly ungoverned, hosts a syllabic consonant and then governs V_1 . As a consequence, the prefix geminates by spreading into the unlicensed initial site. The reader will have noticed that the medial consonants in (23b) and (23c) remain non-syllabic, regardless of their sonority status. If sonority hierarchy were decisive in the choice of the syllabic consonant, the form in (23b) would have selected the simplex variant of the prefix. That is, the medial consonant /r/ would have been syllabic, therefore licensing the initial CV.

5 Complex combinations of causatives and reciprocals

As stated so far, my analysis predicts that only the inner prefix will vary in length when both causative and reciprocal prefixes cooccur in the same form. This is exactly the situation in causativized reciprocals, as shown in Tashlhiyt Berber (24).

(24)	<i>Verb</i>	<i>Reciprocal</i>	<i>Causative + Reciprocal</i>	
a.	knu	mmknu	smmknu	‘make (them) lean mutually’
	rwi	mmrwi	smmrwi	‘make soil each other’
	dru	mmdru	smdru	‘make each other share meal’
	k ^w ti	mmk ^w ti	smmk ^w ti	‘make each other recall’
b.	ɣawn	mɣiwin	smɣiwin	‘make help mutually’
	ħada	mħidi	smħidi	‘make close to each other’
	gabɫ	ngibil	sngibil	‘make each other face’
	fhm	nfihim	snfihim	‘make each other understand’

In these forms, only the reciprocal *m-* varies in length for it has access to the initial CV, as opposed to the causative /s-/ which remains constantly simplex. In addition, the reciprocal prefix undergoes dissimilation ($m > n$), as in [ngibil] and [nfihim], for reasons to be discussed in section 6. The examples represented in (25) illustrate the length variation just discussed.

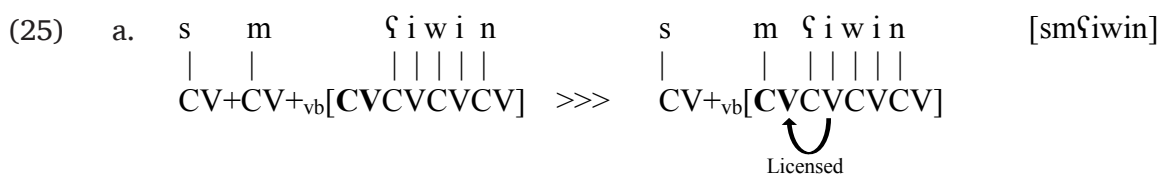

(27)	<i>Verb</i>	<i>Reciprocal</i>		
a.	gabl	ngibil	*mgibil	'face each other'
	samħ	nsimih	*msimih	'forgive each other'
	sllm	nsillim	*msillim	'greet each other'
	fk	nnfku	*mmfku	'give each other'
b.	rwi	mnrwi	*nrwi	'dirty mutually'
	ɣawn	mɣiwin	*nɣiwin	'help each other'
	knu	mmknu	*nnknu	'lean mutually'
	dru	mmdru	*ndru	'share meal'

The reciprocal prefix undergoes dissimilation without regard of its length, similarly to what has been noticed in the case of sibilant harmony in causatives. However, only consonants trigger labial dissimilation (27a); labial vowels and glides are by no means involved in the process (27b).

Focusing on sibilant harmony, Elmedlaoui (1992: 16) addresses the problem in terms of feature spreading. His analysis accounts for all cases where the causative prefix undergoes harmony. However, it fails to explain why this prefix remains unchanged when it is followed by another prefix. The same holds for the reciprocal prefix, which resists dissimilation when another prefix intervenes before the stem.

Strict adjacency to the stem seems necessary in order for both processes to occur. Consider the verb [ħʃʃim] 'be ashamed'. In the causative form [ʃħʃʃim] 'cause shame', the prefix undergoes anterior harmony (/s-/ > [ʃ]). Interestingly, when adding the reciprocal prefix immediately before the stem, the causative /s-/ remains unchanged while the reciprocal /m-/ dissimilates into [n], leading to the form [snħiʃʃim] 'cause (them) shame each other'.

In light of these facts, one can suggest that sibilant harmony and labial dissimilation operate within a specific domain, of which the causative and the reciprocal prefixes are not part when they occur in the outer position. This domain, put in brackets throughout this paper, is defined as follows:

- (28) The domain of the verb consists of the stem template, preceded by an initial empty CV.

The initial CV allows for the causative and the reciprocal prefixes to attach inside the domain of the verb. In complex forms where both prefixes cooccur, only the inner prefix has access to the initial site, and can therefore interact with the segmental content of the stem. That is, in causativized reciprocal forms like [snħiʃʃim], only the reciprocal prefix attaches inside the domain of the verb, hence dissimilation of /m-/ into [n].

- (29) /smħiʃʃim/ >> [snħiʃʃim]
- | | | | | | | | |
|----|--------------------|--------------|---|---|---|---|--|
| s | m | ħ | i | ʃ | i | m | |
| | | | | | | | |
| CV | +CV _{+vb} | [CVCVCVCVCV] | | | | | |
- >>
- | | | | | | | |
|----|-----|--------------|---|---|---|---|
| s | n | ħ | i | ʃ | i | m |
| | | | | | | |
| CV | +vb | [CVCVCVCVCV] | | | | |
- 
- Licensed

As shown above, the initial CV is licensed by the following vowel, thereby allowing the adjacent prefix to move into the domain of the verb. As a result, this prefix dissimilates into [n] while the outer prefix resists anterior harmony.

Another interesting feature which deserves to be studied relates to the imperfective formation and the way it interacts with the causative prefix. The next section turns to this issue. An analysis at the interface between phonology and syntax will be proposed in order to account for the cooccurrence restrictions the imperfective markers undergo with the causative marker.

7 Templatic competition

In Berber, the imperfective is formed either by geminating a consonant in the stem or by prefixing *tt-*, both of which may operate jointly with vowel insertion (cf. Dell & Elmedlaoui 1988; Bensoukas 2001; Lahrouchi 2001; 2008; 2010, among others). However, causative verbs never undergo gemination or *tt-*prefixation; rather they involve vowel insertion to mark the imperfective. This is shown for Tashlhiyt in (30).

(30)	<i>Verb</i>		<i>Causative</i>			
	<i>Aorist</i>	<i>Imperfective</i>	<i>Aorist</i>	<i>Imperfective</i>		
a.	‘reach’	laḥg	tt-laḥag	s-laḥg	s-laḥag	*ttslaḥag
	‘sit down’	gawr	tt-gawar	s-gawr	s-gawar	*ttsgawar
	‘nibble’	knkr	tt-knkar	s-knkr	s-knkar	*ttsknkar
	‘be washed’	arud	tt-arud	ss-ird	ss-irid	*tssirid
	‘fear’	awd	tt-awd	ss-iwd	ss-iwid	*tssiwid
b.	‘wake up’	nkr	nkkkr	ss-nkr	ss-nkar	*ssnkkkr
	‘arrive’	lkm	lkkkm	ss-lkm	ss-lkam	*sslkkm
	‘be tired’	rmi	rmmmi	ss-rmi	ss-rmaj	*ssrmmmi
	‘wear’	ls	lssa	ss-ls	ss-lsa	*sslssa
	‘heat up’	ry	rqqqa	ss-ry	ss-rya	*ssrqqqa

The verbs in (30a) form their imperfective by means of *tt-*prefixation, while those in (30b) resort to gemination. The use of one or the other mechanism depends on the segmental content of the base: verbs containing no more than three consonants and no full vowel, except in the final position, resort to gemination; *tt-*prefixation applies elsewhere. Under the hypothesis that the causative imperfective is derived from the imperfective, the verbs in (30) would have used the causative prefix jointly with gemination or *tt-*prefixation, leading to the starred forms in the rightmost column. But as we can see, these forms are not attested. In fact, the verbs in (30b) degeminate their medial consonant, and those in (30a) lose the imperfective prefix. Instead, a vowel, generally /a/,⁷ appears after the second consonant of the base verb.

The incompatibility of the imperfective markers with the causative prefix is very similar to that found in nouns. Indeed, the construct state marker [u-] never occurs with the feminine prefix [t-]: For instance, FS [afrux] ‘boy’ alternates with CS [ufrux]. In the feminine form, [tafruxt] ‘girl’ alternates with [tfruxt], and not *[tufruxt] as would be

⁷ The inserted vowel can also be a copy of the preceding vowel in the stem.

expected everything being equal. In Lahrouchi (2013), it is argued that the gender and the CS markers compete for the same position in the template, namely the consonantal position in the initial site. It is proposed that gender [t-] connects to this position before the CS [u] (< /w/) is added. Following the same reasoning, I assume that the imperfective and the causative are derived from the same base, and that in the imperfective causative their markers compete for the empty initial C position, resulting in forms where only the causative marker is realized. The forms represented in (31) illustrate the proposal.

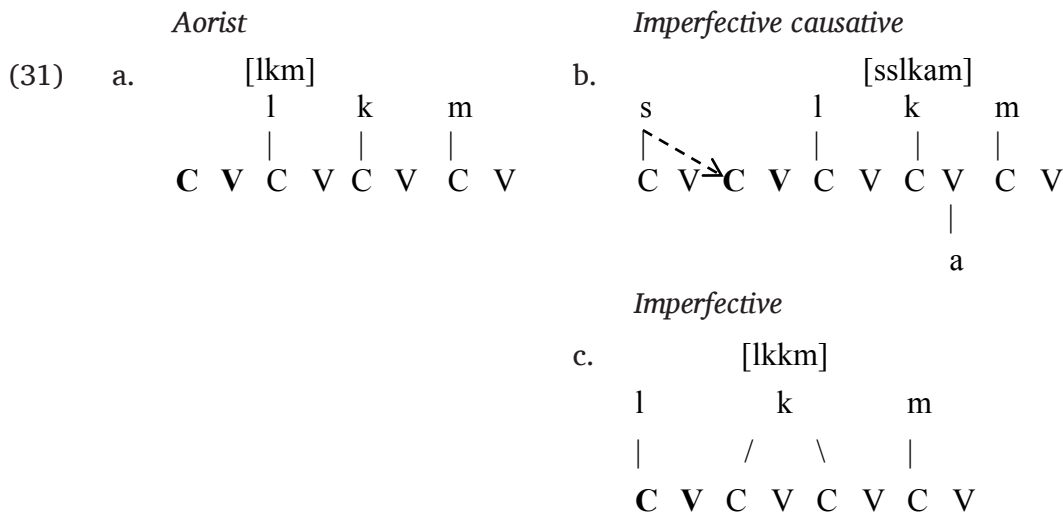

Only one empty C slot is available in the initial position of the template (31a). The causative prefix connects to this empty position, leaving vowel insertion as the only option to mark the imperfective (31b). In other words, causative formation takes precedence over imperfective gemination, yielding a form from which medial gemination is absent. (31b) further shows that the causative prefix enters the derivation with its own skeletal position (the leftmost CV). It then geminates through spreading into the initial site. In the absence of the prefix (31c), the empty CV allows geminating the medial consonant by associating segments to the template from the edges inward (Yip 1988).

The incompatibility of the imperfective [tt-] with the causative /s-/ obtains along the same lines, as illustrated with the pair [ttgawar] / [sgawar] beneath.

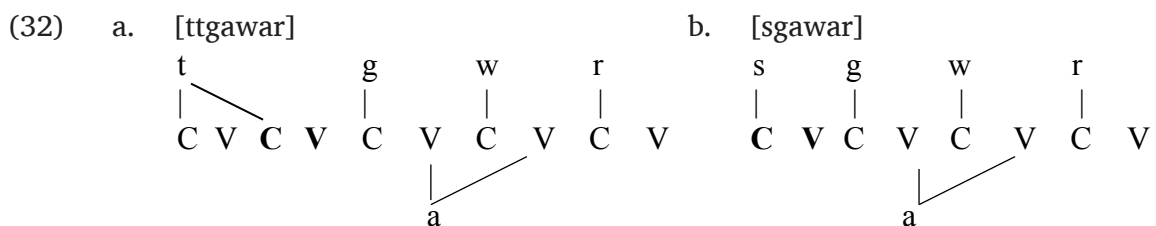

In (32a), the imperfective prefix connects to two C positions, one of which belongs to the initial CV. The same position hosts the causative prefix in (32b), leaving vowel insertion as the only marker for the imperfective.

Berber, like many other Afroasiatic languages, makes extensive use of non-concatenative morphological operations, and templates play a central role not only in arranging the segmental material but also in accounting for the cooccurrence restrictions certain grammatical markers display. The absence of the imperfective marker in the causative forms emerges in this context. However, one can still ask why causative /s-/

takes precedence over imperfective gemination and tt-prefixation. We need to explain how the causative prefix has access to the initial empty CV before the imperfective is formed.

One way to address this issue lies in the syntactic structure of the verbal phrase. Causativization as an operation on argument structure is generally argued to occur lower in the structure than the aspect marker.⁸ Using three distinct projections and a head movement approach (cf. Travis 1984 on *the Head Movement Constraint*; Baker 1988 on *Incorporation*), we can posit that the initial CV is generated under VP, the projection immediately above which the causative is formed, while the imperfective is generated higher in the structure under AspP.⁹ The form in (33) illustrates the derivation.

(33) *[ttsgawar] / [sgawar]

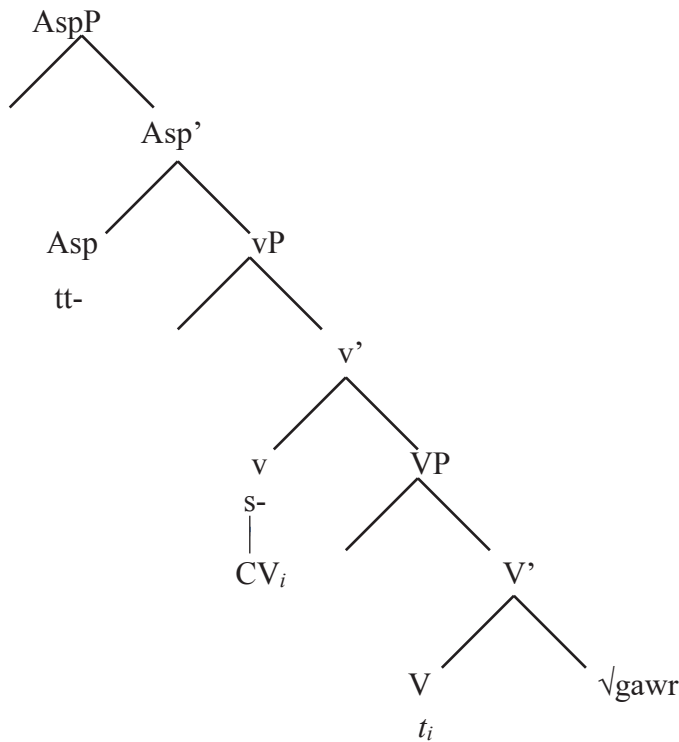

The empty initial CV in (33) moves from the head position of the VP to adjoin to the upper causative morpheme /s-/. When raised to Asp, the initial site no longer contains a C position available for the imperfective marker, thus ruling out the form *[ttsgawar]. Recall from the above discussion that [tt-] connects to two C slots, one of which belongs to the initial site. However, the vowel /a/ between the last two consonants, which comes with the imperfective prefix, remains in situ in the causative form.

However, one problem might arise with the linearization of the syntactic structure in (33). Under the standard view that moved heads left-adjoin the upper heads, we expect the linear order of affixes to be mirror-image of the order of syntactic constituents. That is, we expect the imperfective marker to appear before the causative. Actually, this is true

⁸ The vP projection has been originally proposed for causative formation (cf. Chomsky 1995; Kratzer 1996). Arbaoui (2010: 77–78) argues that in Classical Arabic the causative (also called Form II) is generated under vP, lower in the structure than the imperfective.

⁹ The same reasoning underlies the analysis proposed by Achab (2006: 187), although the author dispenses with little v. Instead, he uses an additional VP projection as the locus of causativization (see also Guerssel 1986).

to the extent that it concerns languages with concatenative morphology, and in which templates play no specific role. In Berber, templates play a central role in arranging the order of morphemes. The structures of the type in (33) are meant to reflect the alleged templatic character of this language. Under the assumption that templates determine the linearization of grammatical information, the empty initial CV, which undergoes movement, is intended to explain the competition between the causative and the imperfective markers. The outcome of this competition does not require any specific statement about the order of affixes, since only the causative marker is realized. If the realization of the causative and the imperfective markers were not under templatic control, we would have had a form like *[ss-t-gawar], where the causative marker occurs in the outer position.¹⁰

Similarly to the case explained in (33) above, the incompatibility of the causative marker with the imperfective gemination follows from the fact that these markers compete for the same CV site. Since the causative is generated lower in the structure than the imperfective, the medial root consonant /k/ no longer has a C position for gemination. The form in (34) illustrates the derivation.

(34) *[sslkkm] / [sslkam]

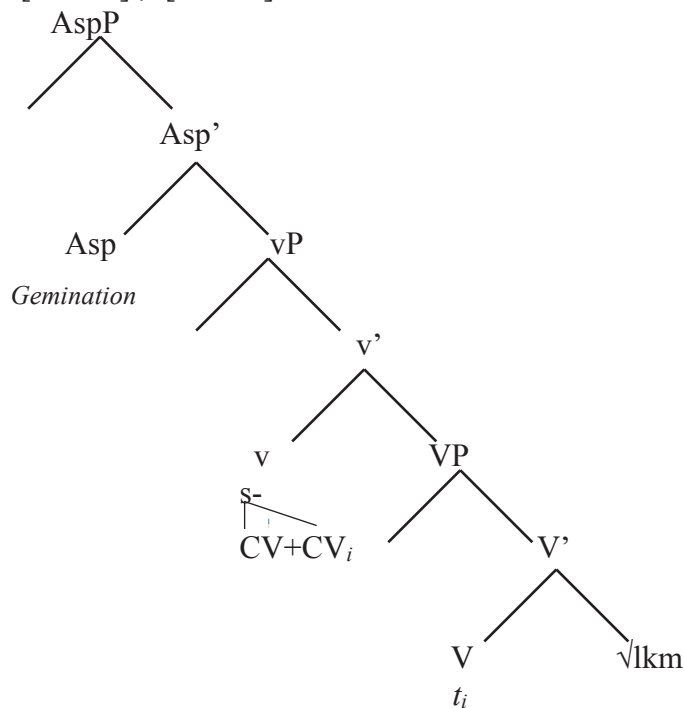

¹⁰ The same reasoning holds for gender and number marking in nouns: The suffixed part of the gender marker (t...-t) is deleted, just like the imperfective marker in verbs, when the number marker is added (e.g. [afrix] 'boy' / [t-afrix-t] 'girl' / [t-ifrix-in] 'girls', not *[tifrxtin]). The issue of the linearization of morphemes needs a thorough treatment which goes beyond the scope of this paper. The morphology of Berber, like that of many other Afroasiatic languages, displays many forms where the linear order of morphemes challenges Baker's Mirror Principle (1985). One interesting example comes from verbal inflection: Under the view that Gender is projected lower in the structure than Number and Person (cf. Fassi Fehri 1984; 1992; Shlonsky 1989 on Semitic), we expect the verb stem to be followed immediately by the gender marker, then number and person (i.e. verb + gender + number + person). The order attested in Berber is actually the reverse. In the preterit, the verb stem is followed by number, then gender, while the person marker is prefixed (e.g. [t-nkr-m-t] 'you stood up (FM)'). Similar facts are found in Arabic (Lowenstamm 2011: 170) and Ethio-Semitic (Rose 1996).

The empty initial CV in (34) moves from the head position of the VP to adjoin to the upper causative morpheme /s-/. When raised to Asp, the initial site no longer contains a C position available for medial consonant gemination, thus ruling out the form *[sslkkm]. In the absence of the causative morpheme, the initial site provides the empty C position needed to achieve gemination, yielding the form [lkkm] ‘arrive-imperfective’.

Complex combinations of the causative and the reciprocal morphemes are obtained in the same way. The causative reciprocal forms of the type discussed in section 5 show that only the reciprocal /m-/ (inner prefix) varies in length for it has access to the initial CV, as opposed to the causative /s-/ (outer prefix) which remains constantly simplex. Unlike the causative, the reciprocal prototypically selects transitive verbs, be they lexical or derived (i.e. causativized), possibly turning them into intransitives in the sense of Buerning (2004: 03). That is, the reciprocal derives a verb whose argument is both the agent and the internal argument.

Assuming a Reciprocal Projection (or a Reciprocal VoiceP as proposed by Buerning 2004), which takes a VP as its complement, and immediately above which little v introduces causativity, the derivation of the form [smmrwi] proceeds as shown in (35).

(35) [smmrwi]

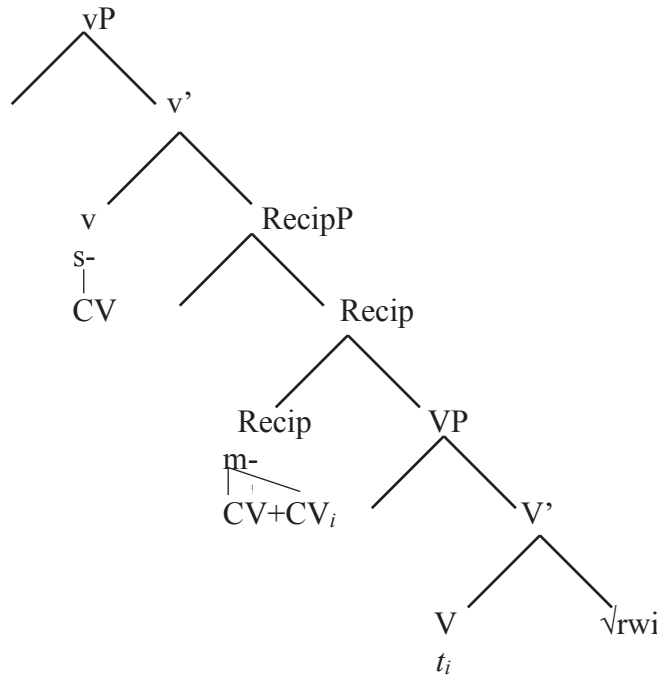

The empty initial CV moves from the head position of the VP to adjoin to the upper reciprocal morpheme m-. Because unlicensed (see section 3.2), the initial site is filled by means of spreading, resulting in the gemination of the reciprocal morpheme. The causative, projected immediately above RecipP, is left with only one consonantal position and therefore remains ungeminated.

Templatic competition at the interface between syntax and phonology allows unifying the analysis of the cooccurrence restrictions of the causative and the imperfective, and the length variation of the reciprocal and the causative. However, it only partially accounts for the facts about the imperfective of reciprocals. Unlike causatives which resist both gemination and tt-prefixation in the imperfective, reciprocals only repel gemination. That is, all reciprocal forms resort to tt-prefixation, regardless of the mechanism their bases select. Consider the following forms in Tashlhiyt.

(36)		<i>Verb</i>		<i>Reciprocal</i>		
		<i>Aorist</i>	<i>Imperfective</i>	<i>Aorist</i>	<i>Imperfective</i>	
a.	‘lean’	knu	knnu	mm-knu	tt-mm-knu	*mmknnu
	‘soil’	rwi	rwwi	mm-rwi	tt-mm-rwi	*mmrwwi
	‘share meal’	dru	drru	mmdru	tt-mm-dru	*mmdrru
b.	‘oversee’	gabl	tt-gabal	n-gibil	tt-n-gibil	
	‘help’	ɣawn	tt-ɣawan	m-ɣiwin	tt-m-ɣiwin	
	‘count’	ħasb	tt-ħasab	n-ħisib	tt-n-ħisib	

The base verbs in (36a) undergo gemination in the imperfective, while the corresponding reciprocals opt for tt-prefixation (hence the starred forms in the rightmost column). In contrast, the verbs in (36b) uniformly resort to tt-prefixation. According to my analysis, the incompatibility of the reciprocal prefix with the imperfective gemination follows from the fact that both markers compete for the same CV site. Since the reciprocal is generated lower in the structure than the imperfective, the medial consonant no longer has a C position for gemination. This is shown in the structure beneath.

(37) [mmrwi] / *[mmrwwi]

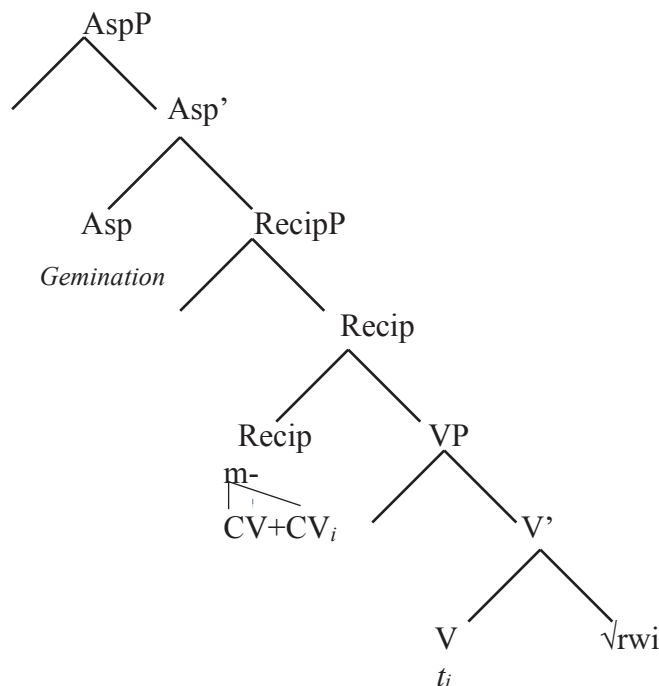

The empty initial CV moves from the head position of the VP to adjoin to the upper reciprocal morpheme m-, leading to its gemination. When raised to Asp, the initial site no longer contains a C position available for imperfective gemination, thus ruling out the form *[mmrwwi]. The behaviour of tt-prefixation needs further investigation in order to determine the exact nature of this morpheme, in relation to the passive. Indeed, both markers share almost the same phonological exponent (e.g. Tashlhiyt [ak^wr] ‘steel’ / [tt-ak^wr] (imperfective) / [ttj-akar] (passive); [xdm] ‘work’ / [tt-xdam] (imperfective) / [ttu-xdam] (passive)). According to Kossmann (2002), /tt-/ diachronically evolved

from “medio-passive”, whereas gemination is viewed as the prototypical marker of the imperfective. It is precisely this marker that behaves uniformly throughout the derivation, combining neither with the causative nor with the reciprocal.

8 Conclusion

The typology put forth in Lowenstamm (1999) distinguishes two types of languages: (i) type I languages such as French where the initial CV is always licensed and used as a cliticisation site, and (ii) type II languages such as Hebrew where the initial site is not always licensed but where a uniformity convention allows using it as if it is always unlicensed. In this paper, an attempt has been made to pinpoint a third type of languages, namely Berber, in which the initial site is not always licensed, and an item-by-item computation is necessary to determine the way it is activated. I have argued that the length variation of the causative and the reciprocal prefixes depends on the licensing status of the initial site. They remain simplex when the initial CV is licensed, and geminate when it is unlicensed. Complex combinations of those prefixes have shown that only the prefix which has access to the initial site varies in length. The same reasoning holds for apparently unrelated phenomena of selective harmony and dissimilation. I have argued that the causative prefix harmonizes with the sibilant in a stem when it is associated inside the domain of the verb, of which the initial site is part. Likewise, the reciprocal morpheme undergoes labial dissimilation when it has access to the initial site. Within a syntactic approach, I have also discussed the cooccurrence restrictions the causative and the imperfective markers undergo: I have argued that the causative marker is generated lower in the structure than the imperfective, resulting in forms where only the former is realized. The same reasoning underlies the incompatibility of the imperfective gemination with the reciprocal marker.

Abbreviations

Asp = Aspect, CS = construct state, FM = feminine, FS = free state, MS = masculine, PG = Proper Government, PL = plural, SG = singular, vP = verbal phrase

Acknowledgements

I would like to thank the anonymous reviewers and the guest editor for their valuable comments. All remaining errors or omissions are of course my own.

References

- Achab, Karim. 2006. *Internal structure of verb meaning: A study of verbs (change of) state in Tamazight (Berber)*. Ottawa: University of Ottawa dissertation.
- Arbaoui, Nora. 2010. La syntaxe de la forme II de l'arabe classique. *Recherches Linguistiques de Vincennes* 39. 69–94. DOI: <https://doi.org/10.4000/rlv.1838>
- Baker, Mark. 1988. *Incorporation: A theory of grammatical function changing*. Chicago, IL: University of Chicago Press.
- Beltzung, Jean-Marc & Cédric Patin. 2007. Quand le schwa n'est pas là...Schwa et consonnes syllabiques en copte. In Olivier Crouzet & Jean-Pierre Angoujard (eds.), *Actes des Journées d'Etudes Linguistiques - Schwa(s)*, 15–20. Nantes: Université de Nantes.
- Bendjaballah, Sabrina. 2001. The “Negative Preterit” in Kabyle Berber. *Folia Linguistica* XXXIV(3–4). 185–220.
- Ben Si Said, Samir. 2014. De la nature de la variation diatopique en Kabyle: étude de la formation des singuliers et pluriels nominaux. Nice: University of Nice dissertation.
- Bensoukas, Karim. 2001. *Stem Forms in the Nontemplatic Morphology of Berber*. Rabat: University Mohammed 5 Doctorat d'Etat Thesis.

- Blaho, Sylvia. 2004. Interactions of sonorant and obstruent voicing. Budapest: Pázmány Péter Catholic University. MA thesis.
- Boukous, Ahmed. 1987. *Phonotactique et domaines prosodiques en berbère*. Paris: University Paris 8 dissertation.
- Cadi, Kaddour. 1987. *Système verbal rifain, forme et sens*. Paris: Selaf.
- Chaker, Salem. 1973. *Le système dérivationnel verbal berbère (dialecte Kabyle)*. Paris: University Paris 3 dissertation.
- Chaker, Salem. 1984. Système des oppositions verbales (kabyle), formes et valeurs. In *Textes en linguistique berbère: Introduction au domaine berbère*, 160–176. Paris: Editions du Centre National de la Recherche Scientifique.
- Chami, Mohamed. 1979. *Un parler amazighe du Rif Marocain*. Paris: University Paris 5 dissertation.
- Chomsky, Noam. 1995. *The Minimalist program*. Cambridge, MA: MIT Press.
- Clark, John & Colin Yallop. 1995. *An introduction to phonetics and phonology*. Oxford: Blackwell.
- Coleman, John. 1996. Declarative syllabification in Tashlhiyt Berber. In Jacques Durand & Bernard Laks (eds.), *Current trends in phonology: Models and methods 1*. 177–218. Salford: European Studies Research Institute, University of Salford.
- Coleman, John. 2001. The phonetics and phonology of Tashlhiyt Berber syllabic consonants. *Transactions of the Philological Society* 99. 29–64. DOI: <https://doi.org/10.1111/1467-968X.00073>
- Dell, François & Mohamed Elmedlaoui. 1985. Syllabic consonants and syllabification in Imdlawn Tashlhiyt Berber. *Journal of African Languages and Linguistics* 7. 105–130. DOI: <https://doi.org/10.1515/jall.1985.7.2.105>
- Dell, François & Mohamed Elmedlaoui. 1988. Syllabic consonants in Berber: Some new evidence. *Journal of African Languages and Linguistics* 10. 1–17. DOI: <https://doi.org/10.1515/jall.1988.10.1.1>
- Dell, François & Mohamed Elmedlaoui. 2002. *Syllables in Tashlhiyt Berber and in Moroccan Arabic*. Dordrecht: Kluwer. DOI: <https://doi.org/10.1007/978-94-010-0279-0>
- Elmedlaoui, Mohamed. 1992. *Aspects des représentations phonologiques dans certaines langues chamito-sémitiques*. Rabat: University Mohammed 5 Doctorat d'Etat Thesis.
- Fassi Fehri, Abdelkader. 1984. Agreement, binding, and coherence. In Michael Barlow & Charles Ferguson (eds.), *Agreement in natural language*, 107–158. Stanford: CSLI.
- Fassi Fehri, Abdelkader. 1992. Sous-spécification, accord et pronoms en arabe. *Revue Québécoise de Linguistique* 22. 117–143. DOI: <https://doi.org/10.7202/602755ar>
- Guerssel, Mohamed. 1986. On Berber verbs of change: A study of transitivity alternations. *Lexicon Project Working Papers #9*.
- Guerssel, Mohamed. 1992. The phonology of Berber derivational morphology by affixation. *Linguistic Analysis* 22(1–2). 03–60.
- Hammane, Khadija. 2010. *La syllabe en berbère tachelhit: que peut apporter la théorie CVCV?*. Paris: University Paris 8, dissertation.
- Iazzi, Elmehdi. 1991. *Morphologie du verbe en tamazight (parler des Aït Attab Haut-Atlas Central): approche prosodique*. Rabat: University Mohammed 5 D.E.S thesis.
- Jebbour, Abdelkrim. 1999. Syllable weight and syllable nuclei in Tachelhit Berber of Tiznit. *Cahiers de Grammaire* 24. 95–116.
- Kaye, Jonathan. 1990. 'Coda' licensing. *Phonology* 7. 301–333. DOI: <https://doi.org/10.1017/S0952675700001214>
- Kaye, Jonathan, Jean Lowenstamm & Jean-Roger Vergnaud. 1990. Constituent structure and government in phonology. *Phonology* 7(2). 193–231. DOI: <https://doi.org/10.1017/S0952675700001184>

- Kossmann, Maarten. 2002. L'origine de l'aoriste intensif en berbère. *Bulletin de la Société Linguistique de Paris* XCVII(1). 353–370. DOI: <https://doi.org/10.2143/BSL.97.1.503764>
- Kratzer, Angelika. 1996. Severing the external argument from its verb. In Johan Rooryck & Laurie Zaring (eds.), *Phrase Structure and the lexicon*, 109–137. Dordrecht: Kluwer Academic Publishers. DOI: https://doi.org/10.1007/978-94-015-8617-7_5
- Lahrouchi, Mohamed 2001. *Aspects morpho-phonologiques de la dérivation verbale en berbère (parler chleuh d'Agadir)*. Paris: University Paris 7 dissertation.
- Lahrouchi, Mohamed. 2003. Manifestations gabaritiques dans la dérivation verbale en berbère tachelhit. *Recherches Linguistiques de Vincennes* 32. 61–82. DOI: <https://doi.org/10.4000/rlv.455>
- Lahrouchi, Mohamed. 2008. A templatic approach to gemination in the imperfective stem of Tashlhiyt Berber. *Studies in African Linguistics* 37(1). 21–60.
- Lahrouchi, Mohamed. 2010. On the internal structure of Tashlhiyt Berber triconsonantal roots. *Linguistic Inquiry* 41(2). 255–285. DOI: <https://doi.org/10.1162/ling.2010.41.2.255>
- Lahrouchi, Mohamed. 2013. Templates, markers and syntactic structure in Tashlhiyt Berber. *Lingua* 133. 53–72. DOI: <https://doi.org/10.1016/j.lingua.2013.03.007>
- Lasri, Ahmed. 1991. *Aspects de la phonologie non-linéaire du parler berbère (chleuh de Tidli)*. Paris: University Paris 3 dissertation.
- Lowenstamm, Jean. 1996. CV as the Only Syllable Type. In Jacques Durand & Bernard Laks (eds.), *Current trends in phonology models and methods*, 419–442. Salford: European Studies Research Institute, University of Salford.
- Lowenstamm, Jean. 1999. The beginning of the Word. In John Rennison & Klaus Kühnammer (eds.), *Phonologica 1996: Syllables !?*, 153–166. The Hague: Thesus.
- Lowenstamm, Jean. 2003. Remarks on mutae cum liquida and branching onsets. In Stephen Ploch (ed.), *Living on the edge: 28 papers in honor of Jonathan Kaye* (Studies in Generative Grammar 62), 339–363. Berlin, New York: Mouton de Gruyter. DOI: <https://doi.org/10.1515/9783110890563.339>
- Lowenstamm, Jean. 2011. The phonological pattern of phi-features in the perfective paradigm of Moroccan Arabic. *Brill's Annual of Afroasiatic Languages and Linguistics* 3. 140–201. DOI: <https://doi.org/10.1163/187666311X562495>
- Naït-Zerrad, Kamal. 1994. *Manuel de conjugaison kabyle*. Paris: L'Harmattan.
- Oostendorp, Marc van. 2004. Variation in phonology, theory and evidence. Ms. Amsterdam: Royal Netherlands Academy of Arts and Sciences.
- Ridouane, Rachid. 2008. Syllables without vowels: Phonetic and phonological evidence from Tashlhiyt Berber. *Phonology* 25. 321–359. DOI: <https://doi.org/10.1017/S0952675708001498>
- Rose, Sharon. 1996. Inflectional Affix Order in Ethio-Semitic. In Jacqueline Lecarme, Jean Lowenstamm & Ur Shlonsky (eds.), *Studies in Afroasiatic grammar*, 337–359. The Hague: Holland Academic Graphics.
- Saa, Fouad. 2010. *Quelques aspects de la morphologie et de la phonologie d'un parler amazighe de Figuig*. Rabat: Publications de l'Institut Royal de la Culture Amazighe.
- Scheer, Tobias. 1996. *Une théorie de l'interaction directe entre consonnes*. Paris: University Paris 7 dissertation.
- Scheer, Tobias. 2004. *A Lateral Theory of Phonology: What is CVCV, and why should it be?* (Studies in Generative Grammar 68.1). Berlin: Mouton de Gruyter. DOI: <https://doi.org/10.1515/9783110908336>
- Scheer, Tobias. 2008. Syllabic and trapped consonants in (Western) Slavic: the same but yet different. In Gerhild Zybatow, Luka Szucsich, Uwe Junghanns & Roland Meyer

- (eds.), *Formal Description of Slavic Languages: The Fifth Conference, Leipzig 2003*, 149–167. Frankfurt am Main: Lang.
- Seigneur-Froli, Delphine. 2001. *De la lénition des “codas” initiales en grec*. Nice: University of Nice DEA thesis.
- Seigneur-Froli, Delphine. 2003. Diachronic consonant lenition & exotic word-initial clusters in Greek: A unified account. *Studies in Greek Linguistics* 23. 345–357.
- Seigneur-Froli, Delphine. 2006. *Statut phonologique du début de mot grec*. Nice: University of Nice dissertation.
- Shlonsky, Ur. 1989. Hierarchies of Agreement. Ms, University of Haifa.
- Travis, Lisa. 1984. *Parameters and effects of word order variation*. Cambridge, MA: MIT dissertation.
- Yip, Moira. 1988. Template morphology and the direction of association. *Natural Language and Linguistic Theory* 6. 551–577. DOI: <https://doi.org/10.1007/BF00134493>

How to cite this article: Lahrouchi, Mohamed. 2018. The left edge of the word in the Berber derivational morphology. *Glossa: a journal of general linguistics* 3(1): 30.1–25, DOI: <https://doi.org/10.5334/gjgl.250>

Submitted: 02 September 2016 **Accepted:** 24 October 2017 **Published:** 05 March 2018

Copyright: © 2018 The Author(s). This is an open-access article distributed under the terms of the Creative Commons Attribution 4.0 International License (CC-BY 4.0), which permits unrestricted use, distribution, and reproduction in any medium, provided the original author and source are credited. See <http://creativecommons.org/licenses/by/4.0/>.

]u[*Glossa: a journal of general linguistics* is a peer-reviewed open access journal published by Ubiquity Press.

OPEN ACCESS 