



**HAL**  
open science

## Stop presupposing the computation of presupposition: the case of the French adjective *seul*.

Pascal Amsili, Céline Raynal, Laurent Roussarie

### ► To cite this version:

Pascal Amsili, Céline Raynal, Laurent Roussarie. Stop presupposing the computation of presupposition: the case of the French adjective *seul*. Proceedings of the Workshop on Information Structure in Context, 2002. halshs-00081618

**HAL Id: halshs-00081618**

**<https://shs.hal.science/halshs-00081618>**

Submitted on 23 Jun 2006

**HAL** is a multi-disciplinary open access archive for the deposit and dissemination of scientific research documents, whether they are published or not. The documents may come from teaching and research institutions in France or abroad, or from public or private research centers.

L'archive ouverte pluridisciplinaire **HAL**, est destinée au dépôt et à la diffusion de documents scientifiques de niveau recherche, publiés ou non, émanant des établissements d'enseignement et de recherche français ou étrangers, des laboratoires publics ou privés.

# Stop presupposing the computation of presuppositions: the case of the French adjective *seul*

Pascal Amsili, Céline Raynal & Laurent Roussarie  
Lattice – Talana – Université Paris 7  
Case 7003, 2 place Jussieu, F-75251 Paris Cedex 05  
{amsili;raynal;roussarie}@linguist.jussieu.fr

## 1 Introduction

The main purpose of this paper is to contribute to a better understanding of what is required to handle the problem of the computation (in the sense of Kamp (2001b)) of presupposition. We try to define a computation framework capable of dealing with complex semantic structures, especially when compositionality seems to be problematically involved.

We concentrate in this paper on some uses of the French adjective *seul* (*only*). We try to provide an accurate description of the behaviour of this item, and then present a representation to account for this behaviour. At last, we tackle the problem of compositionally computing such a representation. Moreover, beyond the linguistic description, we also aim at generic efficiency, in the sense that our computation framework is intended to produce any *plausible* representation of sentences involving a presuppositional trigger such as *seul*.

The paper is organised as follows. In section 2 we review some of the relevant properties of *seul*, from a syntactic and a semantic point of view. The interaction of *seul* with the determiners is very complex, and we restrict ourselves to a limited number of cases. Then we propose an extended version of  $\lambda$ -DRT, which allows us to tackle the issue of compositionality (section 3). In the last part of the paper (section 4), we show in details how the computation can be achieved.

## 2 Data

### 2.1 Some syntactic properties of *seul*

*Seul* is morphologically an adjective in French. When it means ‘lonely’, it has a regular distribution, always occurring after the noun it modifies, within the N' (2a). It can also appear in two other positions: either within the NP, between Det and N (2b), or outside the NP (2c), this last case being restricted to subject positions. In these two positions, *seul* means ‘only’.<sup>1</sup>

- (2) a. Fred a rencontré une fille seule  
*Fred met a lonely girl*  
b. Léa a reçu une seule lettre  
*Léa has received only one letter*  
c. Seul un enfant a lu tous les livres  
*Only a/one child has read all the books*

We deal in this paper only with these two positions, which will be noted [Det *seul* N']<sub>NP</sub> for the NP-internal case, and [*seul* NP]<sub>NP</sub> for the NP-external case. One could argue that in this last case, *seul* is no longer an adjective, but an adverb. However, even in this case, agreement takes place between *seul* and the head of the NP. We take this agreement as evidence for assuming that in all the cases, *seul* is an adjective, syntactically controlled by the head of an NP.

---

<sup>1</sup>There are other cases, where *seul* occurs after the N, like in (1a), which are ambiguous (see the two possible glosses). We do not want to deal with this ambiguity here, for we consider it is syntactic. Semantically, when *seul* means ‘only’, it is equivalent to the [*seul* NP]<sub>NP</sub> structure (here, (1b)).

- (1) a. Quelques hommes seuls sont venus  
*A few lonely men came*  
*A few men only came*  
b. Seuls quelques hommes sont venus

### 2.1.1 [*seul* NP]<sub>NP</sub>

Note that in [*seul* NP]<sub>NP</sub> cases, *seul* can be substituted *salva veritate* with *seulement* (*only*)<sup>2</sup> (3), which is not the case in [Det *seul* N']<sub>NP</sub> structures (*contra* English, where *only* can occur between Det and N).

(3) *Seulement un enfant a lu tous les livres.* ≈(2c)

Structures of the form [*seul* NP]<sub>NP</sub> are quite productive in French, and seem to accept many kinds of NPs: proper names, pronouns or full NPs. However, it turns out that a number of determiners are incompatible with *seul* (4a). Besides, even though examples can be found, the occurrence of *seul* with *peu*, *plusieurs*, *beaucoup* (*de*) is also constrained (4b). See also table 1.

- (4) a. *Seuls ( \*aucun / \*tous les / \*chaque / \*la plupart des ) amis sont venus*  
*Only ( \*no / \*every/all / \*each / \*most ) friend(s) came*  
b. *Seuls ( ?peu de / ?plusieurs / ??beaucoup de ) amis sont venus*  
*Only ( few / several / many ) friends came*

### 2.1.2 [Det *seul* N']<sub>NP</sub>

As for [Det *seul* N']<sub>NP</sub> structures, they seem even more constrained. First, only 4 kinds of determiners are possible at all: *un* (singular indefinite), but not *des* (plural indefinite); *le*, *la*, *les* (singular/plural definite); possessives and demonstratives. All other determiners, even those that combine with *seul* in [*seul* NP]<sub>NP</sub> structures, are excluded (5).

- (5) ( \*Trois / \*Quelques / \*Des / \*Plusieurs ) *seuls amis sont venus*  
( \*Three / \*Some / \*Ø / \*Several ) *only friends came*

There are additional specificities for each of these four determiners, and we briefly review some of them in the sequel.

**Indefinite determiners** *un* (*a/one*) is quite productive in [Det *seul* N']<sub>NP</sub> structures, but two cases have to be distinguished. In non-generic (and non modal) environments, *un seul* conveys the same information as *seul un*, the two structures we have distinguished being thus equivalent (6).

- (6) a. *Un seul élève a trouvé la réponse*  
*'One only pupil has found the answer'*  
b. = *Seul un élève a trouvé la réponse*  
*Only one pupil has found the answer*

However, in generic or modal environments, this equivalence is lost, as (7) shows. In (7a), there is only one miracle that can save us, whereas (7b) just means that *any* miracle can save us.

- (7) a. *Un seul miracle peut nous sauver*  
*'One only miracle can save us'*  
b. ≠ *Seul un miracle peut nous sauver*  
*Only a miracle can save us*

The interaction between 'only' and genericity is a well-known topic, but the precise way it works in French with *seul* still has to be studied. It is the reason why we leave aside these cases in this paper.

One more word about indefinites: no plural indefinite determiner is possible at all in [Det *seul* N']<sub>NP</sub> structures, and the partitive *du*, although not really plural, is excluded as well (8).

- (8) a. *Seul du vin tachait le sol*  
*Only wine stained the floor*  
b. \* *Du seul vin tachait le sol*  
c. *Seul certains meubles sont faits à la main*  
*Only some pieces of furniture are hand-made*  
d. \* *Certains seuls meubles sont faits à la main*

**Definite determiners** We said earlier that [Det *seul* N']<sub>NP</sub> structures accept the definite determiners *le*, *la* and *les*. However, there are additional constraints: definite determiners are excluded when there is no modifier (adjective, participle, relative...) on the N:

- (9) a. # *Le seul ordinateur fonctionne*  
*The only computer works*  
b. *Le seul ordinateur que je possède fonctionne*  
*The only computer which I own works*

---

<sup>2</sup>*Seulement* can occur in many other positions, and of course it cannot always be substituted with *seul*. Since we are dealing here only with the adjective *seul*, these cases won't be considered in this paper.

The interpretation of these examples suggest that the scope of *seul* is restricted to the NP. (9b) means that (i) I own only one computer and (ii) it works.

As for the plural definite Det *les*, it seems in many cases very odd, if not deviant.

- (10) a. ? Les seuls singes du zoo sont des macaques  
*The only monkeys in the zoo are macaques*  
 b. ? J'ai parlé aux seuls invités qui sont venus  
*I've talked with the only guests who came*

We do not have yet a complete understanding of the behaviour of *les* + *seul*, that is why we won't deal with this case in this paper.

### 2.1.3 Possessive and demonstrative determiners

Possessive determiners (singular) are quite common in  $[\text{Det } seul \text{ N'}]_{\text{NP}}$  structures (11a). There seem to be the same kind of problem with the plural as with simple definite Dets (11b). Even though this might not be that easy from the compositional point of view, it seems legitimate to treat them as a special case of definite Det with modifiers: *my friend* = *the friend that I have*.

- (11) a. Mon seul ami m'a trahi  
*My only friend betrayed me*  
 b. ? Il a lu mes seuls livres  
*He read my only books*

Demonstrative determiners are harder to cope with. They seem to occur rather freely, and do not need a modifier (12a). We will not spend much time on these determiners in this paper, assuming that our treatment for definite determiners will adapt easily to this case, which in a way can be reduced to simple definite determiners—e.g., (12b).

- (12) a. Ce seul bruit terrifia les enfants  
*This only noise frightened the children*  
 b. Le seul bruit dont je parle terrifia les enfants  
*The only noise of which I'm talking frightened the children*

### 2.1.4 Summary

We summarize in the table (1) the compatibility of *seul* with determiners in both structures.

Table 1: Acceptability of determiners with *seul*

Det		$[seul \text{ NP}]_{\text{NP}}$	$[\text{Det } seul \text{ N'}]_{\text{NP}}$
<i>le, la</i>	( <i>the (Sing)</i> )	+	+
<i>les</i>	( <i>the (Plur)</i> )	+	?/–
<i>mon, ma</i>	( <i>my (Sing)</i> )	+	+
<i>mes</i>	( <i>my (Plur)</i> )	+	?/–
<i>ce, cet(te), ces</i>	( <i>this/these</i> )	+	+
<i>un</i>	( <i>a/one</i> )	+	+
<i>des</i>	( $\emptyset$ ( <i>Indef. Plur</i> ))	+	–
<i>quelques</i>	( <i>some</i> )	+	–
<i>certains</i>	( <i>some</i> )	+	–
<i>du</i>	( <i>some (partitive)</i> )	+	–
<i>un peu de</i>	( <i>some (partitive)</i> )	+	–
Card		+	–
<i>peu de</i>	( <i>few</i> )	?	–
<i>plusieurs</i>	( <i>several</i> )	?/+	–
<i>beaucoup de</i>	( <i>many/much</i> )	?/–	–
<i>tous les</i>	( <i>every/all</i> )	–	–
<i>aucun</i>	( <i>no</i> )	–	–
<i>chaque</i>	( <i>each</i> )	–	–
<i>la plupart des</i>	( <i>most</i> )	–	–

Let us summarize here what we plan to deal with in this paper, leaving aside a number of cases for space reasons (or because we do not yet have a stable characterization of the data).

- We consider only the two structures  $[seul NP]_{NP}$  and  $[Det\ seul\ N']_{NP}$ , excluding cases where *seul* is an adjective meaning ‘lonely’, and cases where *seul* is ambiguous between a non presuppositional reading (‘lonely’) and a presuppositional reading, this latter case being reducible to the  $[seul NP]_{NP}$  case.
- In  $[Det\ seul\ N']_{NP}$  structures, we consider in this paper only two cases: the singular definite determiner *le/la*, and the singular indefinite determiner *un*. We completely leave aside plural determiners, which have a more complex behaviour. We also exclude the generic/modal cases in this paper. At last, we do not explicitly deal with possessive and demonstrative determiners, considering them as ‘special cases’ of definite determiners.

It is worth noting that the adjective *seul*, even when there is ambiguity, is never focus-sensitive, and it is important to keep this in mind when looking at our English glosses, where ‘only’ is often focus-sensitive and therefore ambiguous. Since we concentrate here on some of the uses of *seul*, focus-sensitivity will not be an issue at all in this work<sup>3</sup>.

## 2.2 Semantic properties

### 2.2.1 $[seul NP]_{NP} VP$

Assuming the classical distinction between presupposition and assertion, we can easily check, via classical tests (Krifka (1993); van der Sandt (1988)), that the presupposition in  $[[Det\ seul\ N']_{NP} VP]$  structures is  $[NP VP]$ . For instance, the presupposition of (13a) is (13b), as (14) shows.

- |   |  |
|---|--|
| <p>(13) a. Seul Jean est venu<br/><i>Only Jean came</i><br/>b. Jean est venu<br/><i>Jean came</i></p> | <p>(14) a. #Seul Jean est venu, et il est venu.<br/><i>Only Jean came, and he came.</i><br/>b. Jean est venu, et seul lui est venu.<br/><i>Jean came, and only him came.</i></p> |
|---|--|

In (14a), the assertion is followed by the presupposition, making the discourse pragmatically deviant. It is not the case in (14b), where the presupposition occurring in the second sentence can felicitously be bound to the first sentence.

This behaviour of *seul* is very regular, we can look at other examples where the presupposition is always the  $[NP VP]$  proposition:

- (15) a. #Seul un étudiant étranger est venu, et il est venu.  
*Only one foreign student came, and he came*  
b. Un étudiant étranger est venu, et lui seul est venu.  
*A foreign student came, and only him came*
- (16) a. #Seuls des enfants étaient présents, et ils étaient présents.  
*Only children were present, and they were present*  
b. Des enfants étaient présents, et seuls eux étaient présents.  
*Children were present, and only them were present*

Other examples include:

- (17) a. Seul du vin tâchait le sol.  
*Only wine stained the floor*  
b. Seuls trois joueurs ont reçu cet honneur.  
*Only three players were honored*  
c. Seules quelques plantes ont résisté au froid.  
*Only a few plants have resisted to the coldness*  
d. Seuls certains concerts sont complets.  
*Only some concerts are sold off*  
e. Seul un peu de brouillard gênait les pilotes.  
*Only a few fog bothered the pilots*  
f. Seuls plusieurs essais fourniront une indication.  
*Only several tries will yield an indication*  
g. Seul beaucoup d’amour permet d’améliorer l’état du malade.  
*Only much love allows the better being of the patient*  
h. Seuls peu d’élèves ont une idée de leur avenir professionnel.  
*Only a few pupils have an idea about their professional future*

---

<sup>3</sup>The adverb *seulement* is focus sensitive in French, but since it is only one of the 3 main means of conveying restriction, the other two (the adjective *seul* and the structure *ne... pas*) not being dependant on the focus, the focus-sensitivity issue do not have in French the importance it has in English.

Note that, as expected, the presupposition triggered by *seul* can combine with other presuppositions, like for instance the one triggered by a definite determiner. For example, it is easy to check that (18a) presupposes (18b), which itself presupposes (18c).

- (18) a. Seul l'ordinateur neuf fonctionne.  
*Only the new computer works*  
 b. L'ordinateur neuf fonctionne.  
*The new computer works*  
 c. Il existe un ordinateur neuf  
*There is a new computer*

We can represent more or less formally this nesting of presuppositions in (19), where  $\langle A|B \rangle$  means that  $B$  is asserted and  $A$  presupposed:

- (19)  $\langle$ The new computer works | Nothing else works $\rangle$   
 =  $\langle$  $\langle$ There is a (unique) new computer | it works $\rangle$  | Nothing else works $\rangle$

Let us now have a look at the asserted part of sentences of the form  $[[seul\ NP]_{NP}\ VP]$ . It is generally assumed that the asserted part is something like 'nothing else does VP' (or, with a positive formulation, 'everything that does VP is what is presupposed to VP'). However, with a closer look at the examples, we can see that there is almost always an ambiguity about the relevant set in question.

- (20) Dans cette salle machine, seuls trois PC fonctionnent  
*In this computer room, only three PCs work*

The presupposition conveyed by (20) is unproblematic: three PC work in the computer room. But the assertion can be either (21a) or (21b).

- (21) a. Everything that works in the room is a PC (excluding Macs, for instance)  
 b. The number of working PCs in the room is (at most) three, the number of other machines that work being irrelevant

Of course, it is no surprise that the context have an influence as soon as uniqueness comes into play, that is why we have taken an example with an explicit context—(20) is talking only about the computer room. But there is something else happening here: it seems that there are two ways of computing the assertion, one taking into account the head of the (subject) NP, the other one independent from the subject NP: (22a) is a translation of (21a), and (22b) is a translation of (21b).

- (22) Let  $W$  be the set of PCs which work,  $CR(x)$  mean 'x is in the computer room'  
 a.  $\forall x ((CR(x) \wedge x \notin W) \rightarrow \neg work(x))$   
 b.  $\forall x ((CR(x) \wedge PC(x) \wedge x \notin W) \rightarrow \neg work(x))$

One way to circumvent this ambiguity would be to state that in both cases, a context  $C$  has to be computed, the semantic representation being then something like (23). Then one would invoke separate principles (pragmatic...) which would yield  $\lambda x C(x) = \lambda x (CR(x) \wedge PC(x))$  in one case, and  $\lambda x C(x) = \lambda x PC(x)$  in the other (and possibly something else in yet other cases).

- (23)  $\forall x ((C(x) \wedge x \notin W) \rightarrow \neg work(x))$

No matter how computationally tractable this option may seem, we don't want to adopt it, for it would make us loose the fact that in one case, the NP is taken into account (in addition to an eventual context) whereas in the other case, only the VP is taken into account. So we just assume that there should be two representations available, like one usually does in case of real ambiguity. Note that the ambiguity does not arise with definite and possessive determiners.

We try now to provide a complete (static) representation for both the presupposed and the asserted parts of sentences of the form  $[[seul\ NP]_{NP}\ VP]$ . We take the two following examples.

- (24) a. Seul un PC marche  
*Only one PC works*  
 b. Seul le nouveau prof est enthousiaste  
*Only the new teacher is enthusiastic*

For (24a), the presupposed part might be represented like in (25a), and the asserted part like in (25b). We put brackets around the condition  $PC(x)$  to remind that two distinct representations should actually be available.  $C$  represents the context in the usual way.

- (25) a. 

$w$
$PC(w)$
$marche(w)$

      b. 

$C$	
$C = ?$	
$x$	$\forall$
$C(x)$ [ $PC(x)$ ] $marche(x)$	
$x = w$	

It is now well-known (from e.g. van der Sandt (1992); Kamp (2001b)) that some kind of variable sharing is necessary to account for the fact that the asserted part says something about a referent introduced in the presupposed part. Here, the discourse referent  $w$  is shared between the two representations.<sup>4</sup>

To account for (24b), we have to deal with the nesting of presuppositions. In (27), (a) and (b) represent the presuppositions and (c) the asserted part. The nesting is not explicitly represented here, we propose a representation for that in the section 3.

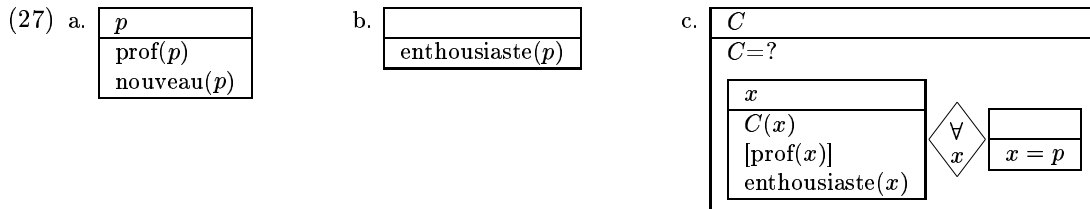

### 2.2.2 [ $\text{Det}_{[+\text{def}]}$ seul $N'$ $W$ ] $_{\text{NP}}$ VP

We consider here only singular definite determiners, and we assume that they occur in [ $\text{Det}$  seul  $N'$ ] $_{\text{NP}}$  only when the  $N'$  is modified. Let  $W$  be the modifier.

- (28) Serena Williams a remporté le seul match complété de la journée à New-York  
*Serena Williams has won the only completed match of the day at New York*

Informally, this utterance says two (more or less) independent things: (i) there was only one completed match this day at N.Y., and (ii) Serena Williams has won this match. The asserted part, (ii), is unproblematic in this case. As for the presupposition, it systematically involves two nested parts, one coming from the definite, and the other from *seul*. To make this clear with a simpler example, let's consider an example parallel to (18):

- (29) Le seul ordinateur neuf fonctionne  
*The only new computer works*

Then, using the same informal notation as before, one can represent (29) in the following way:

- (30)  $\langle$  There is a (unique) only new computer | it works  $\rangle$   
 $= \langle$  Only a new computer exists | it works  $\rangle$   
 $= \langle \langle$  There is a new computer | No other computer is new  $\rangle$  | it works  $\rangle$

So, just like before, but with a different order, we can propose the following representation for (28), which involves three parts:

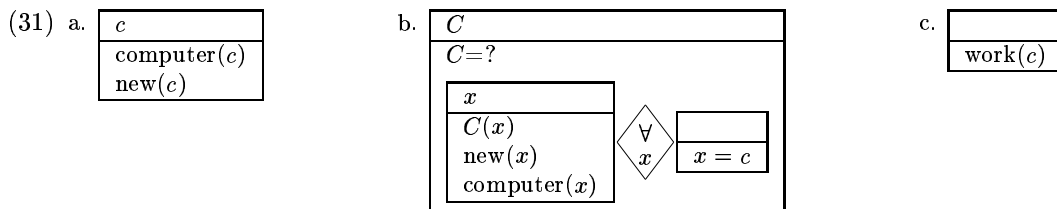

### 2.2.3 [ $un$ seul $N'$ ] $_{\text{NP}}$ VP

The last case we consider in this paper is [ $un$  seul  $N'$ ]. We already saw that, if we except generic or modal cases, the interpretation of such cases is similar to that of constructions in [*seul un*  $N'$ ], except that this time they do not carry an ambiguous reading, as the NP is involved in the restriction of the uniqueness condition:

- (32) a. Un seul enfant est endormi  
*An only child is asleep* ( $|\llbracket child \rrbracket \cap \llbracket asleep \rrbracket| = 1$ )  
 b. Seul un enfant est endormi  
*Only one child is asleep* ( $|\llbracket child \rrbracket \cap \llbracket asleep \rrbracket| = 1$ )

<sup>4</sup>To avoid the problems with variable-sharing, one could try to formalise the semantics differently. For instance, the two parts conveyed by (26a) can be represented as (26b) and (26c).

- (26) a. Only three PCs work  
 b. Presupposition:  $|PC \cap W| \leq 3$   
 c. Assertion:  $|PC \cap W| \geq 3$

Here, there is no variable sharing any more, the link between the two representations being the number 3, derived from the quantifier. However, such a representation is not easily generalisable and raises various problems, and we won't pursue this line here.

It is thus not necessary to come back here to the details of the representation in this case. We refer the reader to the section 2.2.1. In such cases, the difficulty we have comes from the fact that we want to derive the same interpretation with *seul* occurring in clearly different syntactic positions. We deal with this problem in section 4.3.

### 3 Augmented $\lambda$ -DRT

Now that we have outlined a number of cases of complex presupposition triggering (and, more generally, of complex semantic representation), the question we have to tackle is: how can one obtain such representations? Or, in other words: how to design a grammatical component—and preferably a compositional one—that enables one to construe the expected representations?

It has been convincingly shown, since e.g. Stalnaker (1974); Karttunen (1974); Karttunen and Peters (1979); Heim (1983), that the semantic treatment of presuppositions has better to be examined from a dynamic semantics perspective. Accordingly, we choose to couch our computation in the framework of DRT (Kamp and Reyle, 1993). The approach we are to set up here is noticeably closely related to Kamp’s (2001a; 2001b). But we somewhat differ in a purpose we are following: contrarily to Kamp, we do not wish to deal with the problem of presupposition projection. Concerning this issue, we mainly rely on van der Sandt (1992) (or Asher and Lascarides (1998)), as we choose to postpone the task of the justification of the presuppositions against discourse. So our position can be stated as follows: any presupposition that is triggered in a sentence will be stored by the grammar as a *potential* presupposition, whenever it will be eventually bound or cancelled or justified or accommodated in the context.

Moreover among our concerns is the importance we give to the computational efficiency of the framework. In particular we want to avoid any “mysterious” construction operation in order to obtain the representation which is expected. That is why we make a point of implementing our analysis in a fully-fledged compositional framework, namely the  $\lambda$ -DRT, based on very simple and very standard mathematical operations (e.g.  $\lambda$ -abstraction, function application,  $\beta$ -conversion...).

#### 3.1 $\lambda$ -DRT

We take as a starting point a (more or less standard) version of  $\lambda$ -DRT (Asher, 1993; van Eijck and Kamp, 1997; Blackburn and Bos, 1999). Roughly speaking, the  $\lambda$ -DRT can be viewed as an adapted Montague Grammar where formulas are replaced with “boxes” (i.e. DRS). We define the syntax of  $\lambda$ -DRT by means of  $ME_a$ , the set of meaningful expressions of type  $a$ :

- if  $K$  is a DRS, then  $K \in ME_t$ ;
- if  $K \in ME_a$  and  $\nu$  is a variable of type  $b$ , then  $\lambda\nu K \in ME_{\langle b, a \rangle}$ ;
- if  $K_1 \in ME_{\langle a, b \rangle}$  and  $K_2 \in ME_a$ , then  $K_1(K_2) \in ME_b$ ;
- if  $K_1, K_2 \in ME_t$ , then  $K_1 \oplus K_2 \in ME_t$ .

From the second point, it is possible to perform  $\lambda$ -abstraction over a DRS. For instance, the noun *man* corresponds to  $\lambda x \langle \{ \}, \{ \text{man}(x) \} \rangle$ , and the determiner *a* corresponds to  $\lambda P \lambda Q \langle \{ u \}, \{ \} \rangle \oplus P(u) \oplus Q(u)$ . The  $\oplus$  symbol stands for the operator of sequential merging. Merging is the operation by means of which DRSS can be built progressively from pieces or portions of DRSS. We will assume the definition below, following Blackburn and Bos (1999).<sup>5</sup>

- if  $K_1 = \langle U_1, C_1 \rangle$  and  $K_2 = \langle U_2, C_2 \rangle$ , then  $K_1 \oplus K_2 = \langle U_1 \cup U_2, C_1 \cup C_2 \rangle$ .

We will also make use of a device borrowed from (van Eijck and Kamp, 1997), the function *intro*, which for each ( $\lambda$ -)DRS  $K$  yields the set of discourse markers *introduced* by  $K$ . Thus a notation such as  $x \in \text{intro}(D)$  will appear in some DRS conditions during the computation. However it is not, by itself, a genuine truth condition that eventually defines the content of an utterance; it should rather be seen as an instruction operator which enhances our  $\lambda$ -calculus language. Hence if  $D = \langle U, C \rangle$ , *intro*( $D$ ) is merely a shorthand for  $U$ ; note however that  $U$  is thus accessed in a compositional fashion.

<sup>5</sup>But see also van Eijck and Kamp (1997) for an extended discussion on sequential merging. Note that the  $\oplus$  we use here should correspond to van Eijck and Kamp’s  $\bullet$ .



### 3.2 Augmentation

Our point is that one cannot compute the presuppositional and asserted contents of a sentence in *disjunction*. Obvious as it may seem, such a statement involves a significant augmentation of the language of the compositional DR-theoretic calculus. Indeed a so-called presuppositional trigger does not only indicate what is to be presupposed, it gives clues as well on how to settle what is not presupposed, viz. what is asserted. As we want to keep separated presuppositional and asserted information, the grammar has to operate on two “workbenches” simultaneously. To embody this idea, we propose that  $\lambda$ -DRT be used to build a more complex representation structure than a mere DRS.

The  $\lambda$ -terms handled by the calculus will be based upon a structure we call a T-DRS (for Trailer-DRS). A T-DRS is of the form  $\langle K \mid K' \rangle$ , where  $K'$  is a DRS and  $K$  is a DRS or a T-DRS.  $K'$  corresponds to the asserted content of the sentence being computed, and  $K$  corresponds to its (possibly nested) presuppositional content(s) (it is the information that will have to be justified against the context).<sup>6</sup> T-DRSS undergo  $\beta$ -conversion in a rather normal way, that is the  $\beta$ -conversion distributes over the two part of a T-DRS:  $\lambda x \langle K \mid K' \rangle (a) \longrightarrow \langle K_{[a/x]} \mid K'_{[a/x]} \rangle$ . As for merging T-DRSS, the operation must not be distributive; it applies only on the asserted part:

- $\langle K \mid K' \rangle \oplus K_0 = \langle K \mid K' \oplus K_0 \rangle$
- $K_0 \oplus \langle K \mid K' \rangle = \langle K \mid K_0 \oplus K' \rangle$

As an example, here is the contribution of the verb *to regret* (we make abstraction of temporal and eventual information).

$$\text{regret} \rightsquigarrow \lambda K \lambda x \left\langle K \left| \begin{array}{|c|} \hline \text{regret}(x, \wedge K) \\ \hline \end{array} \right. \right\rangle$$

*Regret* leads to presuppose that  $K$  is true, and to assert that  $x$  is in a “regret-attitude” towards the proposition described by  $K$ . Another example is the entry of the definite article *the*:

$$\text{the} \rightsquigarrow \lambda P \lambda Q \left\langle \begin{array}{|c|} \hline u \\ \hline \end{array} \oplus P(u) \left| Q(u) \right. \right\rangle$$

In words, *the* contributes to presuppose that there is a  $u$  which is a  $P$ , and to assert that  $u$  “does  $Q$ ”.

## 4 Computation

Thus equipped with our “augmented  $\lambda$ -DRT toolbox”, we will now propose several compositional analysis of the semantic contributions of *seul* that we have outlined in § 2. As different distributions for *seul* lead to different global semantic representations, our computational model has to split the formal import of *seul* into several lexical entries.

### 4.1 *Seul*<sub>1</sub> NP VP

Recall that  $[\text{seul NP}]_{\text{NP}} \text{VP}$  may be ambiguous (see § 2.2.1): the asserted uniqueness is either restricted to  $[\text{VP}]$  or to  $[\text{NP}] \cap [\text{VP}]$ . The ambiguity will be rendered by assuming two slightly different entries for this use of *seul*. Here, a natural way to proceed is to consider that *seul* is a function from NPs to NPs; that is *seul* is a syntactic operator of type  $\langle \langle (e, t), t \rangle, \langle (e, t), t \rangle \rangle$ . Here are the entries we propose:

$$\begin{array}{l} \text{seul}_1 \rightsquigarrow \lambda P \lambda Q \left\langle P(Q) \left| \begin{array}{|c|} \hline C \\ \hline C=? \\ \hline \begin{array}{|c|} \hline z \\ \hline C(z) \end{array} \oplus Q(z) \diamond \begin{array}{|c|} \hline z \\ \hline z \in \text{intro}(P) \end{array} \right. \right. \right\rangle \quad (\text{first reading}) \\ \text{or} \\ \lambda P \lambda Q \left\langle P(Q) \left| \begin{array}{|c|} \hline C \\ \hline C=? \\ \hline \begin{array}{|c|} \hline z \\ \hline C(z) \end{array} \oplus P(z) \oplus Q(z) \diamond \begin{array}{|c|} \hline z \\ \hline z \in \text{intro}(P) \end{array} \right. \right. \right\rangle \quad (\text{second reading}) \end{array}$$

<sup>6</sup>Note that, as in Kamp (2001a,b), if a T-DRS appears in the left side of a higher T-DRS, the whole of it will count as a (nested) presupposition.

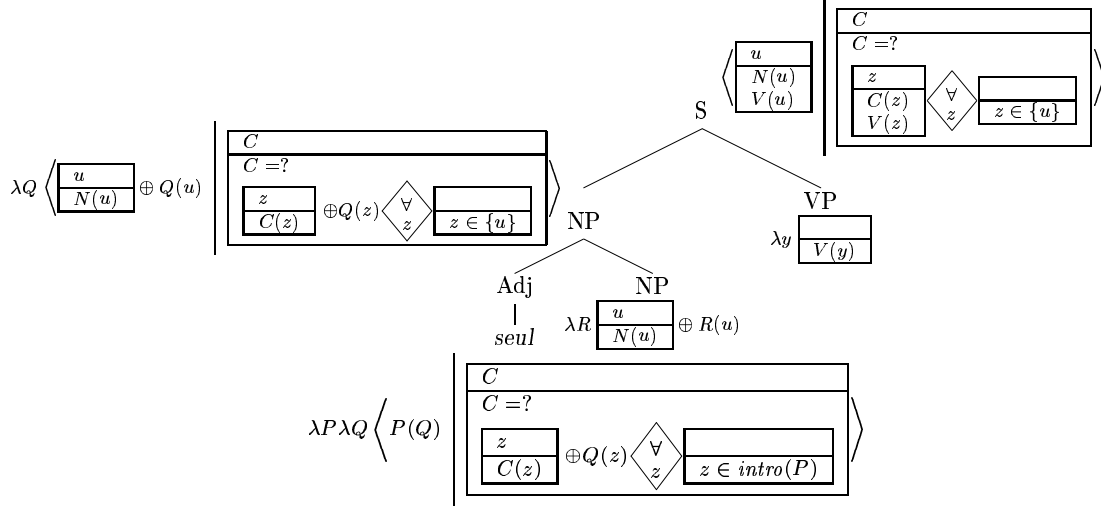

Figure 1: Computation of *seul* NP VP

The application  $P(Q)$  that fills the left-hand part of the  $\tau$ -DRS ensures that the presupposition is effectively the meaning of the whole sentence “deprived” of *seul* (as  $P$  and  $Q$  will be converted into the semantics of, respectively, NP and VP). The right-hand part of the  $\tau$ -DRS illustrates the use we make of *intro*. Here it is asserted that, under a relevant contextual condition  $C$  to be specified, anything ( $z$ ) that verifies  $\llbracket Q \rrbracket$ , and possibly  $\llbracket P \rrbracket$ , is a member of the universe introduced by the constituent  $P$ .

First note that when the determiner of the NP is *tous les* (all/every), *la plupart* (most) or *aucun* (no),  $\text{intro}(P) = \emptyset$ ,<sup>7</sup> and then  $z \in \text{intro}(P)$  is inconsistent. That may explain why some quantifiers are ruled out (cf. table 1). Second, according to Kamp and Reyle (1993) (and also following Link (1983)), we assume that some other plural terms whose quantification is determined by a duplex condition introduce a (plural) discourse marker, i.e. a discourse referent for a sum individual. So in these cases  $\text{intro}(P)$  is not empty. E.g. *trois N* (*three N*) amounts to (33), where  $\in_i$  is the *individual membership* relation and  $N^*$  is the plural predicate corresponding to  $N$ .<sup>8</sup>

$$(33) \quad \begin{array}{|c|} \hline X \\ \hline |X| = 3 \\ \hline \begin{array}{|c|} \hline x \\ \hline x \in_i X \end{array} \diamond \begin{array}{|c|} \hline \forall x \\ \hline N(x) \end{array} \\ \hline \end{array} \quad \text{or} \quad \begin{array}{|c|} \hline X \\ \hline |X| = 3 \\ \hline N^*(X) \\ \hline \end{array}$$

Normally the condition  $z \in \text{intro}(P)$  has to be interpreted (or rather rewritten) as follows:

- $z \in \text{intro}(P) \Leftrightarrow \neg(\forall x \in \text{intro}(P), z \neq x)$

The interpretation is correct for the cases when (we assume that) the NP introduced several discourse markers (e.g. with coordinations: *seuls Yorick et Horacio me soutiennent/Only Yorick and Horacio support me*). But, on the other hand, this is not the actual semantics we expect when  $\text{intro}(P)$  contains plural discourse markers. Indeed  $z = X$  would be correct only in the cases of collective readings (e.g. *Seuls (exactement) quatre personnes peuvent soulever le frigo/Only (exactly) four persons can lift the fridge*). In most other cases, we expect the condition to be  $\neg(\forall X \in \text{intro}(P), z \notin X)$  (or  $z \not\subseteq X$ , as  $z$  is not typed). In order to give a general account for the semantics of the asserted content we have to fix the condition  $z \in \text{intro}(P)$ , i.e. to replace  $\in$  by a relation which sensitive to the type of (the elements of) its right-hand member.

## 4.2 *Le seul*<sub>2</sub> N W VP

Here *seul* is not ambiguous, but it has a quite different combination. Indeed we saw that *seul* requires a mandatory complement for the noun it combines with. The composition rule that accounts for this constraint will be  $: N^l \rightarrow \text{seul N W}$ , and here *seul* is an operator of type  $\langle\langle e, t \rangle, \langle\langle e, t \rangle, \langle e, t \rangle\rangle\rangle$ , i.e. it

<sup>7</sup>E.g. *tous les/every N*  $\rightsquigarrow \lambda P \langle \{ \}, \{ \{ \{ x \}, \{ N(x) \} \} \} \rangle \langle \{ \}, \{ P(x) \} \rangle$ .

<sup>8</sup>Cf. Link (1983); we define  $\in_i$  from his *i-part* relation  $\Pi$ :  $a \in_i b \leftrightarrow a \Pi b \wedge a$  is an atom.

takes two  $\langle e, t \rangle$ -predicates as arguments and yields an  $\langle e, t \rangle$ -predicate.<sup>9</sup> So here is the entry we propose for our second *seul*:

$$seul_2 \rightsquigarrow \lambda P_1 \lambda P_2 \lambda z \left\langle P_1(z) \oplus P_2(z) \right\rangle \left[ \begin{array}{l} C \\ C = ? \\ \boxed{v} \\ C(v) \oplus P_1(v) \oplus P_2(v) \diamond \forall v \boxed{v = z} \end{array} \right]$$

In this representation, it is first presupposed that an individual ( $z$ ) belongs to the extensions of both  $P_1$  and  $P_2$  (these variables will be converted into  $N$  and  $W$  respectively). And—for the moment—it is asserted that anything that belongs to  $[[P_1 \wedge P_2]]$  (in a relevant context  $C$ ) is actually  $z$ . Note that  $z$  is not yet existentially introduced; that will be achieved by the contribution of the determiner. And since the determiners we are dealing with here are definite, they also carry a presuppositional effect, viz. the content of the  $N'$  just construed will be consigned to the eventual presupposed slot of the sentence T-DRS. This process is illustrated in Fig. 2.

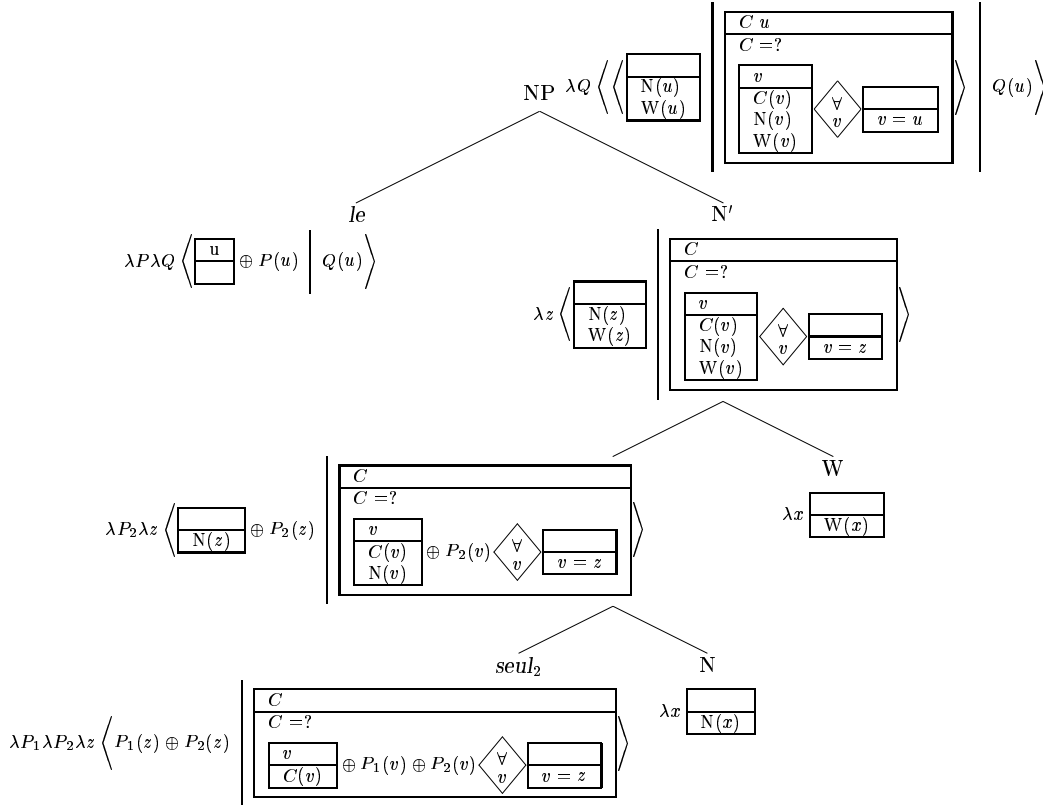

Figure 2: Computation of  $[\text{Det}_{[+def]} \text{seul } N' W]_{\text{NP}}$

### 4.3 *Un seul*<sub>3</sub> N VP

Within the limits of our present study, we have stated above that *un seul*<sub>3</sub> N VP turns out to be logically equivalent to *seul un* N VP, but it carries no ambiguity. Moreover the lexical entry of *seul*<sub>3</sub> should not be exactly similar to the one of *seul*<sub>1</sub> because, besides its different syntactic position, *seul*<sub>3</sub> only occurs with the singular indefinite article *un(e)*. To reflect this behaviour we propose that *seul*<sub>3</sub> combines with the determiner so as to yield a (complex) determiner, i.e. *seul*<sub>3</sub> will be of type  $\langle\langle e, t \rangle, \langle\langle e, t \rangle, t \rangle\rangle$  (see an illustration Fig. 3).

<sup>9</sup>A noun ( $N$ ) is assigned a  $\lambda$ -expression of type  $\langle e, t \rangle$  in a standard way. I.e.  $N \rightsquigarrow \lambda x \{\{ \}, \{N(x)\}\}$ . Normally,  $W$  is also of type  $\langle e, t \rangle$ , and  $W \rightsquigarrow \lambda x \{\{ \}, \{W(x)\}\}$ . However, it is known that as a (noun) modifier, in attributive position,  $W$  must be promoted to the type  $\langle\langle e, t \rangle, \langle e, t \rangle\rangle$ . Therefore the entry  $W_{\text{attr}} \rightsquigarrow \lambda K \lambda x K(x) \oplus \{\{ \}, \{W(x)\}\}$  correspond to the rule:  $N' \rightarrow N W$ . But here, for *le seul*  $N W$ , we consider that the composition is:  $N' \rightarrow \text{seul } N W$  (i.e. *seul*( $N$ )( $W$ )), so  $W$  remains an  $\langle e, t \rangle$  predicate, being an argument of *seul*. Hence *seul* is an operator of type  $\langle\langle e, t \rangle, \langle\langle e, t \rangle, \langle e, t \rangle\rangle\rangle$ .

$$seul_3 \rightsquigarrow \lambda\Psi\lambda P\lambda Q \left\langle \Psi(P)(Q) \right\rangle \left| \begin{array}{l} w \ C \\ C = ? \\ \hline \begin{array}{|c|} \hline z \\ \hline C(z) \end{array} \oplus P(z) \oplus Q(z) \diamond \begin{array}{|c|} \hline \forall \\ \hline z \end{array} \begin{array}{|c|} \hline \\ \hline z = w \end{array} \\ \hline \end{array} \right\rangle$$

In this representation, the uniqueness condition in the asserted part respects our expectation from § 2.2.3, but its formulation differs purposefully from the one for  $seul_1$  in § 4.1: it *states the existence* of an individual,  $w$ , on which is based the uniqueness; what amounts to *assert* that the set of individuals which verifies  $C$ ,  $P$  and  $Q$  is of cardinality 1.

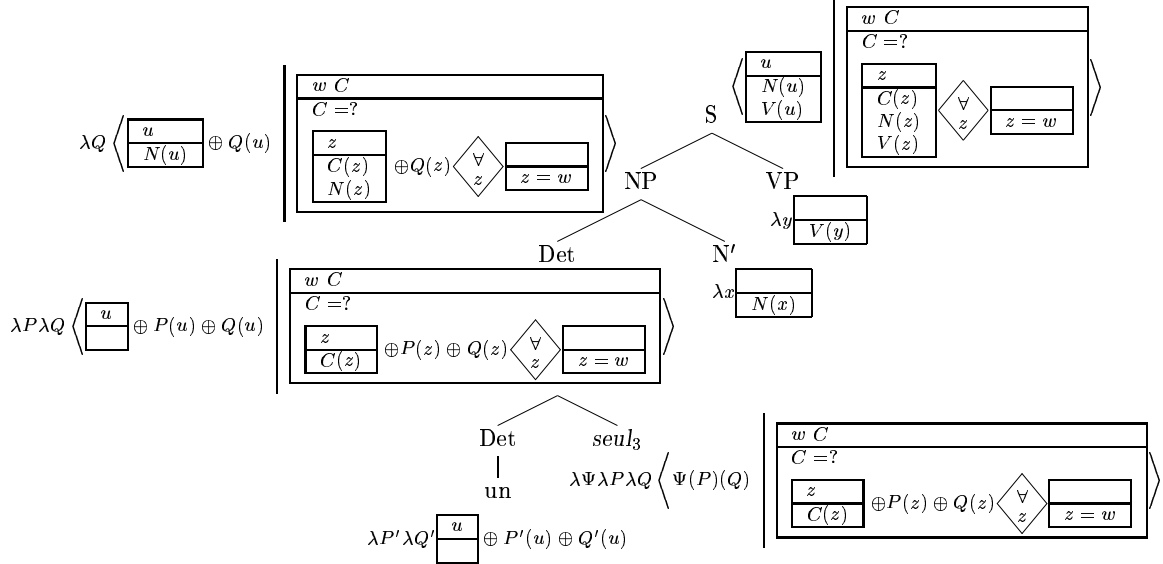

Figure 3: Computation of *un seul N' VP*

## 5 Conclusion

In this paper, we have outlined the way we think  $\lambda$ -DRT can be augmented to account for the computation of presupposition. We find this approach fruitful for at least the following reasons:

- the same mechanism can be used to compute logical forms (e.g., DRSS) compositionally and to compute presupposition
- it allows for the formalisation of the interaction of several presuppositions, which happens quite often, and becomes soon quite hard to formalise
- it is compatible with the compositional component of  $\lambda$ -SDRT (Roussarie and Amsili, 2002).

Of course, we have little to say here about what Kamp (2001a) calls the justification of presupposition. We assume our final representations are appropriate inputs for this justification, whether it relies on rhetorical devices like in Asher and Lascarides (1998), or more specific procedures like in van der Sandt (1992); Kamp (2001b). Moreover we have left open the issue of whether our formalisation would satisfy some requirements of the dynamic semantic treatment of presupposition, and for instance the constraints that Beaver (1992) has dubbed *Sensitivity*, *Dynamicity* and *Weakness*. Our tentative answer will be that it surely does. The components of a  $\tau$ -DRS can be assigned dynamic semantic values which fit in with the constraints, provided that one knows in what order each component must be added into (or justified against) the discourse context. It is known that some presuppositions should be justified before the asserted content updates the context, as in (34a), and that some others should be justified after, as in (34b).

(34) a. Jack's son is bald.

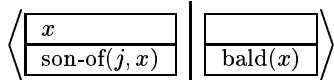

- b. Somebody managed to succeed George IV. (example from Beaver (1992))

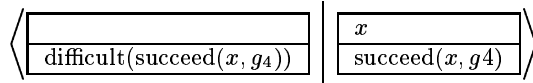

Our idea is that the correct order to proceed can be hinted by a formal property of T-DRSS: the component which should be processed first is the one which introduces a discourse marker shared by other components of the T-DRS. Such a rule, if felicitous, can be formally put e.g. by means of the *intro* function. Moreover it guarantees the eventual interpretability of the T-DRSS components above the somewhat tricky status of variable sharing.

## References

- Asher, N. (1993). *Reference to Abstract Objects in Discourse*. Kluwer, Dordrecht.
- Asher, N. and Lascarides, A. (1998). The semantics and pragmatics of presupposition. *Journal of Semantics*, 15(3):239–300.
- Beaver, D. I. (1992). The kinematics of presupposition. In Dekker, P. and Stockhof, M., editors, *Proceedings of the Eighth Amsterdam Colloquium*, ILLC, University of Amsterdam.
- Blackburn, P. and Bos, J. (1999). *Working with Discourse Representation Structures*, volume II of *Representation and Inference for Natural Language. An Advanced Course in Computational Semantics*. CSLI. (Ms).
- Heim, I. (1983). On the projection problem for presuppositions. In Barlow, M., Flickinger, D., and Wescoat, M. T., editors, *Second Annual West Coast Conference on Formal Linguistics*, pages 114–126, Stanford University.
- Kamp, H. (2001a). The importance of presupposition. In Rohrer, C., Roßdeutscher, A., and Kamp, H., editors, *Linguistic Form and its Computation*. CSLI Publications, Stanford.
- Kamp, H. (2001b). Presupposition computation and presupposition justification: one aspect of the interpretation of multi-sentence discourse. In Bras, M. and Vieu, L., editors, *Semantic and Pragmatic Issues in Discourse and Dialogue. Experimenting with Current Dynamic Theories*, Current Research in the Semantics/Pragmatics Interface, pages 57–84. Elsevier, Oxford.
- Kamp, H. and Reyle, U. (1993). *From Discourse to Logic*. Kluwer Academic Publishers, Dordrecht.
- Karttunen, L. (1974). Presupposition and linguistic context. *Theoretical Linguistics*, 1:181–194.
- Karttunen, L. and Peters, S. (1979). Conventional implicature. In Oh, C.-K. and Dineen, D. A., editors, *Presupposition*, volume 11 of *Syntax and Semantics*, pages 1–56. Academic Press, New York.
- Krifka, M. (1993). Focus and presupposition in dynamic interpretation. *Journal of Semantics*, 10.
- Link, G. (1983). The logical analysis of plurals and mass terms: A lattice-theoretical approach. In Bauërle, R., Schwarze, C., and von Stechow, A., editors, *Meaning, Use, and Interpretation of Language*, pages 302–323. Walter de Gruyter, Berlin.
- Raynal, C. (2002). Calcul effectif des présuppositions : *seul, aussi, même*. Mémoire de DEA, Université Paris 7.
- Roussarie, L. and Amsili, P. (2002). Discours et compositionnalité. In *Actes de la 9ème Conférence sur le Traitement Automatique des Langues Naturelles (TALN 2002)*, volume 1, pages 383–388, Nancy.
- Stalnaker, R. C. (1974). Pragmatic presuppositions. In Munitz, M. K. and Unger, P. K., editors, *Semantic and Philosophy*, pages 197–213. New York University Press, New York.
- van der Sandt, R. A. (1988). *Context and Presupposition*. Croom Helm, London.
- van der Sandt, R. A. (1992). Presupposition projection as anaphora resolution. *Journal of Semantics*, 9(4):333–377.
- van Eijck, J. and Kamp, H. (1997). Representing discourse in context. In van Benthem, J. and ter Meulen, A., editors, *Handbook of Logic and Language*, pages 179–237. Elsevier, Amsterdam.
- von Stechow, K. (1997). Bare plurals, bare conditionals, and *only*. *Journal of Semantics*, 14(1):1–56.